



# APPROVED MINUTES

## February 15, 2024, Standards Committee Meeting

March 28, 2024

TO: Standards Committee

FROM: Scott Trammell, Secretary

RE: Minutes from the February 15, 2024, Standards Committee Meeting

The Standards Committee meeting was called to order by Mr. Novak, sitting in for Mr. Pankow, Chair, at 09:00 a.m. on Thursday, February 15, 2024, which was held virtually via Teams (Microsoft application). The meeting was adjourned at 10:10 a.m. Next meeting is March 21, 2024.

The following committee members were in attendance:

Novak, Joseph\*, Chairman, Director, Construction Management  
Boruff, Dave, Traffic Engineering  
Dave, Kumar, Pavement Engineering  
Harris, Tom\*\*, Construction Technical Support  
Hauser, Derrick\*\*, Construction Management  
Koch, Mike, District Construction, Fort Wayne District  
Orton, Mark, Highway Engineering  
Rearick, Anne, Bridge Management  
Reilman, Jim, Materials and Tests  
White, Peter, Bridge Engineering  
Wooden, John, Contract Administration

\*Proxy for Pankow, Gregory

\*\*Proxy for Pelz, Kurt

\*\*\*Proxy for Novak, Joseph

Also, the following attendees were present:

Aguirre, Frank, INDOT  
Awwad, Nathan, INDOT  
Bazlamit, Subhi M, INDOT  
Blanchard, Jacob, INDOT  
Bruno, Joseph, INDOT  
Coffin, Delaney, INDOT

Leckie, John, IRMCA  
Mouser, Elizabeth, INDOT  
Mueller, Bart, INDOT  
Nelson, Mike, INDOT  
Osborn, Dan, ICI  
Perugu, Kshitija, INDOT

Coulter, Josh, Hoosier Co.  
 Cruz, Elena, INDOT  
 Davis, Herbert, INDOT  
 Duncan, Thomas, FHWA  
 Fisher, Steve, INDOT  
 Hailat, Mahmoud, INDOT  
 Harding, Matthew, INDOT  
 Jacobs, David, INDOT  
 Kachler, Mischa, INDOT  
 Lamkin, Sara, INDOT  
 Laracuenta, Luis, INDOT

Podorvanova, Lana, INDOT  
 Poturalski, Jim, INDOT  
 Powell, Traci, INDOT  
 Prescott, Eleanor, INDOT  
 Russell, Melissa, INDOT  
 Schmidt, Darren, Rinker Pipe  
 Shi, Runfa, INDOT  
 Smutzer, Katherine, INDOT  
 Thornton, Donald, INDOT  
 Trammell, Scott, INDOT

The following items were discussed during the meeting:

**A. GENERAL BUSINESS**

OLD BUSINESS

*(No items were listed)*

NEW BUSINESS

1. *Approval of the Minutes from the January 18, 2024 meeting*

Mr. Novak requested a motion to approve the Minutes from the January 18, 2024 meeting.

Motion: Mr. Orton  
 Second: Mr. Boruff  
 Ayes: 10  
 Nays: 0

ACTION: PASSED AS SUBMITTED

**B. CONCEPTUAL PROPOSAL**

*(No items were listed)*

**C. STANDARD SPECIFICATIONS, SPECIAL PROVISIONS, AND STANDARD DRAWINGS PROPOSAL**

OLD BUSINESS

[Item No. 2 \(1/18/24\)](#)

[Mr. Boruff](#)

[pg. 4](#)

Recurring Special Provisions:

801-x-xxx  
 801-x-xxx  
 801-x-xxx  
 801-x-xxx

TEMPORARY CURB RAMP  
 TEMPORARY ACCESSIBLE PEDESTRIAN PATH  
 TEMPORARY PEDESTRIAN CHANNELIZER  
 AUDIBLE INFORMATION DEVICE

## Standard Drawings:

*E 801-TPAR series*

(proposed new)

ACTION:

PASSED AS REVISED

NEW BUSINESSItem No. 1 Mr. Reilman pg. 27

## Recurring Special Provision:

106-C-277

BUILD AMERICA, BUY AMERICA ACT  
REQUIREMENTS

ACTION:

PASSED AS REVISED

Item No. 2 Mr. Reilman pg. 32

## Recurring Special Provision:

501-R-769

QC/QA PORTLAND CEMENT CONCRETE  
PAVEMENT, PCCP

ACTION:

PASSED AS REVISED

Item No. 3 Mr. Reilman pg. 37

## Recurring Special Provision:

504-R-757

LONGITUDINAL TINING

ACTION:

PASSED AS SUBMITTED

Item No. 4 Mr. Reilman pg. 43

## 2024 Standard Specifications:

605.02

Materials

610.02

Materials

ACTION:

PASSED AS SUBMITTED

Item No. 5 Mr. Reilman pg. 47

## 2024 Standard Specifications:

909.10

Non-Epoxy PCC Sealers

ACTION:

PASSED AS SUBMITTED

Item No. 6 Mr. Boruff pg. 51

## Recurring Special Provision:

604-R-XXX

*SIDEWALKS, CURB RAMPS, STEPS, AND HANDRAILS*

ACTION:

WITHDRAWN

cc: Committee Members  
FHWA  
ICI

STANDARD SPECIFICATIONS, SPECIAL PROVISIONS AND STANDARD DRAWINGS

REVISION TO SPECIAL PROVISIONS AND STANDARD DRAWINGS

PROPOSAL TO STANDARDS COMMITTEE

PROBLEM(S) ENCOUNTERED: A wide range of pedestrians may be affected by a work zone, including the young, elderly, and people with disabilities. To better provide accessible temporary facilities for pedestrians and to help satisfy federal rules on pedestrian access there is a need to standardize details and create recurring special provisions for related devices and features.

PROPOSED SOLUTION: Establish a new Standard Drawing series for temporary pedestrian access routes (801-TPAR) and create recurring special provisions for [1] temporary curb ramps, [2] temporary accessible pedestrian paths, [3] temporary pedestrian channelizers, and [4] audible information devices.

APPLICABLE STANDARD SPECIFICATIONS: 801

APPLICABLE STANDARD DRAWING: Proposed new series on temporary pedestrian access routes (801-TPAR).

APPLICABLE DESIGN MANUAL CHAPTER: IDM §503-3.04(13)

APPLICABLE SECTION OF GIFE: §22

APPLICABLE RECURRING SPECIAL PROVISION OR PLAN DETAILS: N/A

PAY ITEMS AFFECTED: N/A

APPLICABLE SUB-COMMITTEE ENDORSEMENT: The proposed RSP and Standard Drawings have been reviewed by INDOT's ADA Technical Advisory Committee and industry.

IF APPROVED AS RECURRING SPECIAL PROVISION OR PLAN DETAILS, PROPOSED BASIS FOR USE: Required for all contracts with **801-11990, 801-12641, 801-12862, 801-12863**, *temporary curb ramp, temporary accessible pedestrian path, temporary pedestrian channelizer, or audible information device*, pay items.

IMPACT ANALYSIS (attach report): Yes

Submitted By: Joe Bruno on behalf of Dave Boruff  
Title: Sr. Traffic Engineer, Signals & Markings  
Division: Traffic Engineering  
Email: [jbruno@indot.in.gov](mailto:jbruno@indot.in.gov)  
Date: 1-22-2024

STANDARD SPECIFICATIONS, SPECIAL PROVISIONS AND STANDARD DRAWINGS

REVISION TO SPECIAL PROVISIONS AND STANDARD DRAWINGS

IMPACT ANALYSIS REPORT CHECKLIST

*Explain the business case as to why this item should be presented to the Standards Committee for approval. Answer the following questions with Yes, No or N/A.*

Does this item appear in any other specification sections? No

Will approval of this item affect the Qualified Products List (QPL)? No

Will this proposal improve:

Construction costs? No

Construction time? Yes

Customer satisfaction? Yes

Congestion/travel time? No

Ride quality? No

Will this proposal reduce operational costs or maintenance effort? No

Will this item improve safety:

For motorists? No

For pedestrians? Yes

For construction workers? Yes

Will this proposal improve quality for:

Construction procedures/processes? Yes

Asset preservation? No

Design process? Yes

Will this change provide the contractor more flexibility? No

Will this proposal provide clarification for the Contractor and field personnel? Yes

Can this item improve/reduce the number of potential change orders? Yes

Is this proposal needed for compliance with:

Federal or State regulations? Yes

AASHTO or other design code? Yes, PROWAG

Is this item editorial? No

Provide any further information as to why this proposal should be placed on the Standards Committee meeting Agenda: On 8/8/2023, the U.S. Access Board issued the final rule for the Public Right-of-way Accessibility Guidelines and this proposal will further compliance with the requirements for temporary pedestrian facilities.

REVISION TO SPECIAL PROVISIONS AND STANDARD DRAWINGS

---

801-x-xxx TEMPORARY CURB RAMP (proposed new)  
801-x-xxx TEMPORARY ACCESSIBLE PEDESTRIAN PATH (proposed new)  
801-x-xxx TEMPORARY PEDESTRIAN CHANNELIZER (proposed new)  
801-x-xxx AUDIBLE INFORMATION DEVICE (proposed new)

801-x-xxx TEMPORARY CURB RAMP

(Adopted xx-xx-xx)

**Description**

This work shall consist of installing temporary curb ramps for temporary pedestrian access at various intersections in accordance with 105.03.

**Materials**

Materials shall be in accordance with ~~604-02~~ or from the Department's QPL of ADA Compliant Work Zone Devices.

**Construction Requirements**

The Contractor shall place temporary curb ramps to provide ADA compliant temporary access for pedestrians in accordance with 107.08 and as shown on the plans.

The temporary curb ramp shall be a minimum of 48 in. wide and have a slip resistant surface. The ramp shall not have greater than an 8.3% running slope or 2.0% cross slope.

For curb heights greater than 4 in., the temporary curb ramp shall have edge protection. For curb heights less than or equal to 4 in. either the sides shall be flared, or edge protection shall be provided. Edge protection shall be continuous and at least 8 in. in height. Rails or other barriers used for edge protection shall protrude less than 4 in. into the curb ramp.

Handrails are required for curb ramps with a rise greater than 6.0 in. The handrail shall be at least 34 in. but no more than 38 in. above the surface of the ramp and any lower handrail shall be no more than 28 in. above the ramp surface.

The temporary curb ramp shall be placed either perpendicular or parallel to the curb. If the ramp is placed parallel to the curb, a minimum of a 48 in. by 48 in. turning space shall be provided at each required turn location. The turning space shall have a cross slope and running slope of 2.0% or less.

Temporary curb ramps shall be accessed from an ADA compliant landing area.

The temporary curb ramp shall be kept free of any obstructions or trip hazards including debris, mud, construction equipment, and stored materials.

For temporary curb ramps not constructed in accordance with ~~604-02~~ the Contractor shall submit the manufacturer's technical data, specifications and installation instructions for the model selected from the QPL to the Engineer for approval.

REVISION TO SPECIAL PROVISIONS AND STANDARD DRAWINGS

---

- 801-x-xxx TEMPORARY CURB RAMP (proposed new)
- 801-x-xxx TEMPORARY ACCESSIBLE PEDESTRIAN PATH (proposed new)
- 801-x-xxx TEMPORARY PEDESTRIAN CHANNELIZER (proposed new)
- 801-x-xxx AUDIBLE INFORMATION DEVICE (proposed new)

The final layout of the temporary curb ramp at each location shall be as approved by the Engineer prior to closing the existing sidewalk.

**Method of Measurement**

Temporary curb ramps will be measured by the number of units installed, maintained, and removed.

**Basis of Payment**

The accepted quantity of temporary curb ramps will be paid for at the contract unit price per each.

Payment will be made under:

<b>Pay Item</b>	<b>Pay Unit Symbol</b>
Temporary Curb Ramp.....	EACH

The cost of all labor, materials, equipment, and all necessary incidentals required to place the temporary curb ramps during construction operations and removal of the temporary curb ramps after construction is complete shall be included in the cost of the temporary curb ramp.

---

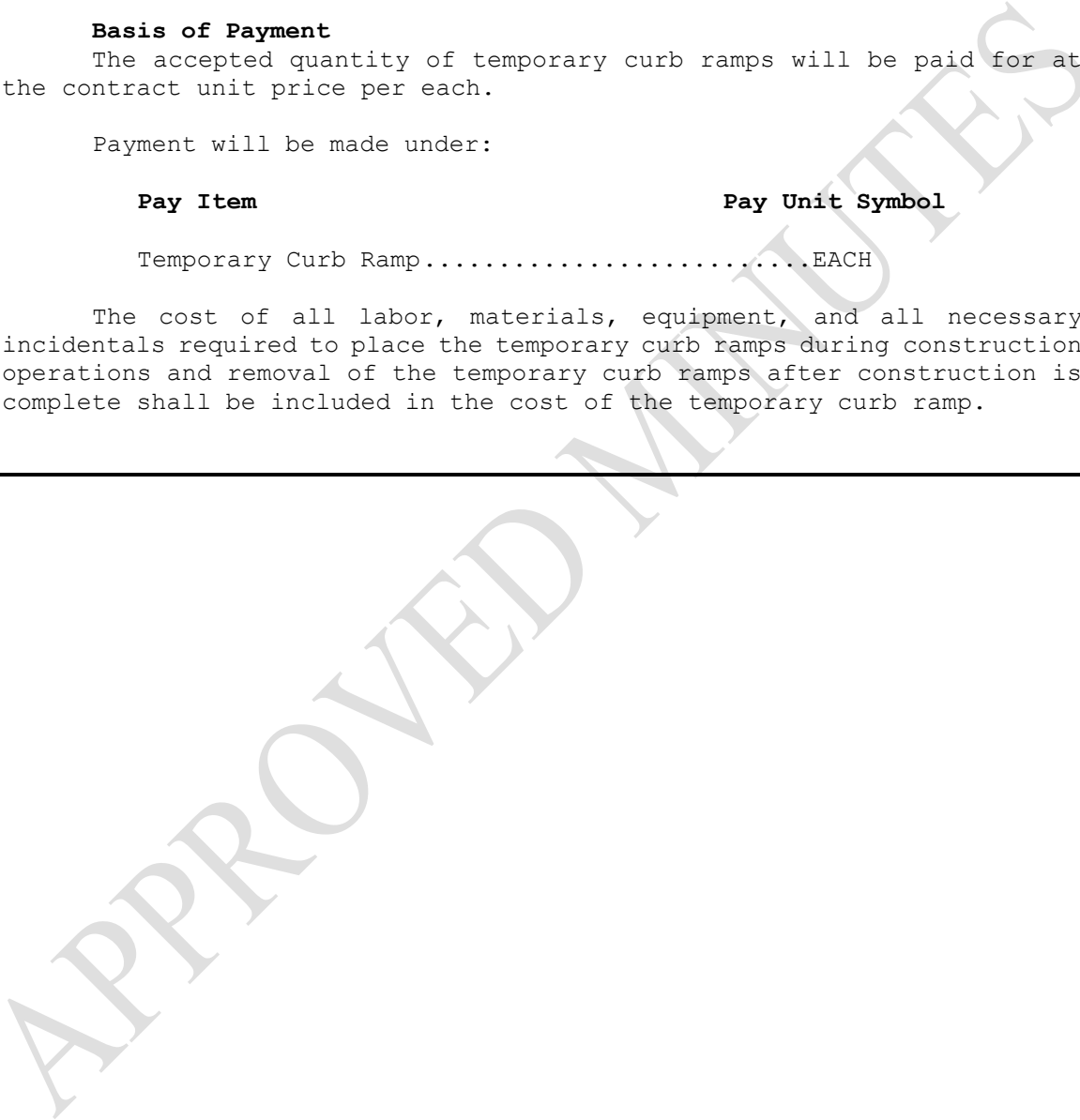

REVISION TO SPECIAL PROVISIONS AND STANDARD DRAWINGS

---

801-x-xxx TEMPORARY CURB RAMP (proposed new)  
801-x-xxx TEMPORARY ACCESSIBLE PEDESTRIAN PATH (proposed new)  
801-x-xxx TEMPORARY PEDESTRIAN CHANNELIZER (proposed new)  
801-x-xxx AUDIBLE INFORMATION DEVICE (proposed new)

801-x-xxx TEMPORARY ACCESSIBLE PEDESTRIAN PATH

(Adopted xx-xx-xx)

**Description**

This work shall consist of installing temporary surfaces for temporary pedestrian access in accordance with 105.03 ~~and as shown on the plans.~~

**Material Requirements**

Materials shall be in accordance with 604.02 or selected from the Department's QPL of ADA Compliant Work Zone Devices and as follows:

The temporary surface shall be a minimum of 48 in. wide. The temporary surface shall not be made of plywood. The temporary surface shall have a firm and stable slip resistant surface.

**Construction Requirements**

The Contractor shall place temporary surfaces to provide ADA compliant temporary access for pedestrians in accordance with 107.08, 604, 801 and as shown on the plans.

Prior to placement of the temporary surface, the existing ground shall be cleared of any removable debris to provide a level surface. The maximum cross slope shall be 2.0%. The existing ground shall be cleared or excavated of natural vegetation as needed for temporary surface construction.

The temporary accessible pedestrian path shall be kept free of any obstructions or trip hazards including debris, mud, construction equipment, and stored materials.

If the temporary surface is less than 60 in. wide a 60 in. by 60 in. passing space shall be provided every 200 ft.

The final layout of the temporary pedestrian access path at each location shall be as approved by the Engineer prior to closing any existing sidewalk.

**Method of Measurement**

Temporary surfaces for temporary pedestrian access will be measured by the square yard.

**Basis of Payment**

The accepted quantity of temporary surfaces for temporary pedestrian access will be paid for at the contract unit price per square yard.

Payment will be made under:



REVISION TO SPECIAL PROVISIONS AND STANDARD DRAWINGS

---

- 801-x-xxx TEMPORARY CURB RAMP (proposed new)
- 801-x-xxx TEMPORARY ACCESSIBLE PEDESTRIAN PATH (proposed new)
- 801-x-xxx TEMPORARY PEDESTRIAN CHANNELIZER (proposed new)
- 801-x-xxx AUDIBLE INFORMATION DEVICE (proposed new)

<b>Pay Item</b>	<b>Pay Unit Symbol</b>
-----------------	------------------------

Temporary Accessible Pedestrian Path .....	SYS
--	-----

The cost of all labor, materials, equipment, railing, handrail, excavation or removal of existing vegetation, in-kind replacement of existing vegetation and all necessary incidentals required to place the temporary surfaces during construction operations and removal of the temporary surfaces after construction is complete shall be included in the cost of the pay item.

---

APPROVED MINUTES

REVISION TO SPECIAL PROVISIONS AND STANDARD DRAWINGS

---

801-x-xxx TEMPORARY CURB RAMP (proposed new)  
801-x-xxx TEMPORARY ACCESSIBLE PEDESTRIAN PATH (proposed new)  
801-x-xxx TEMPORARY PEDESTRIAN CHANNELIZER (proposed new)  
801-x-xxx AUDIBLE INFORMATION DEVICE (proposed new)

801-x-xxx TEMPORARY PEDESTRIAN CHANNELIZER

(Adopted xx-xx-xx)

**Description**

This work shall consist of installing temporary traffic barriers used as pedestrian channelizers to provide a barrier between pedestrians and construction activities at various intersections in accordance with 105.03 ~~and as shown on the plans.~~

**Materials**

Materials shall be in accordance with 801.02 and selected from the Department's QPL ~~for~~ of ADA Compliant Work Zone Devices.

**Construction Requirements**

The Contractor shall place the temporary pedestrian channelizer in accordance with 801.10, as shown on the plans.

The temporary pedestrian channelizer shall have a minimum height of 32 in. The temporary pedestrian channelizers shall interlock such that gaps do not allow pedestrians to stray from the channelized path.

The temporary pedestrian channelizers shall have continuous hand-trailing edging on sides facing pedestrian traffic with a minimum height of 32 in. and a maximum height of 38 in.

The temporary pedestrian channelizer shall have a continuous detection plate on sides facing pedestrian traffic no greater than 2 in. above the ground. The detection plate shall have a minimum height of 8 in.

The top and bottom of the surfaces of the temporary pedestrian channelizer, or the hand-trailing edging and detection plate shall have strips of alternating orange and white reflective sheeting oriented vertically or at a 45° angle.

Temporary pedestrian channelizers shall not block water drainage from the walkway. A gap height or opening from the walkway surface up to 2 in. maximum height is allowed for drainage purposes.

Temporary pedestrian channelizers shall be free of sharp or rough edges, and fasteners shall be rounded to prevent harm to hands, arms, or clothing of pedestrians.

Ballast, or support legs, for the temporary pedestrian channelizers shall be located behind the device away from the pedestrian.

The final layout of the temporary pedestrian channelizer at each location shall be as approved by the Engineer ~~the~~ prior to closing the existing sidewalk.

**Method of Measurement**

REVISION TO SPECIAL PROVISIONS AND STANDARD DRAWINGS

---

- 801-x-xxx TEMPORARY CURB RAMP (proposed new)
- 801-x-xxx TEMPORARY ACCESSIBLE PEDESTRIAN PATH (proposed new)
- 801-x-xxx TEMPORARY PEDESTRIAN CHANNELIZER (proposed new)
- 801-x-xxx AUDIBLE INFORMATION DEVICE (proposed new)

Temporary pedestrian channelizers will be measured by the linear foot, complete and in place.

**Basis of Payment**

The accepted quantity of temporary pedestrian channelizers will be paid for at the contract unit price per linear foot.

Payment will be made under:

<b>Pay Item</b>	<b>Pay Unit Symbol</b>
Temporary Pedestrian Channelizer.....	LFT

The cost of all labor, materials, equipment, and all necessary incidentals required to place the temporary pedestrian channelizers during construction operations and removal of the channelizers after construction is complete shall be included in the cost of the temporary pedestrian channelizer.

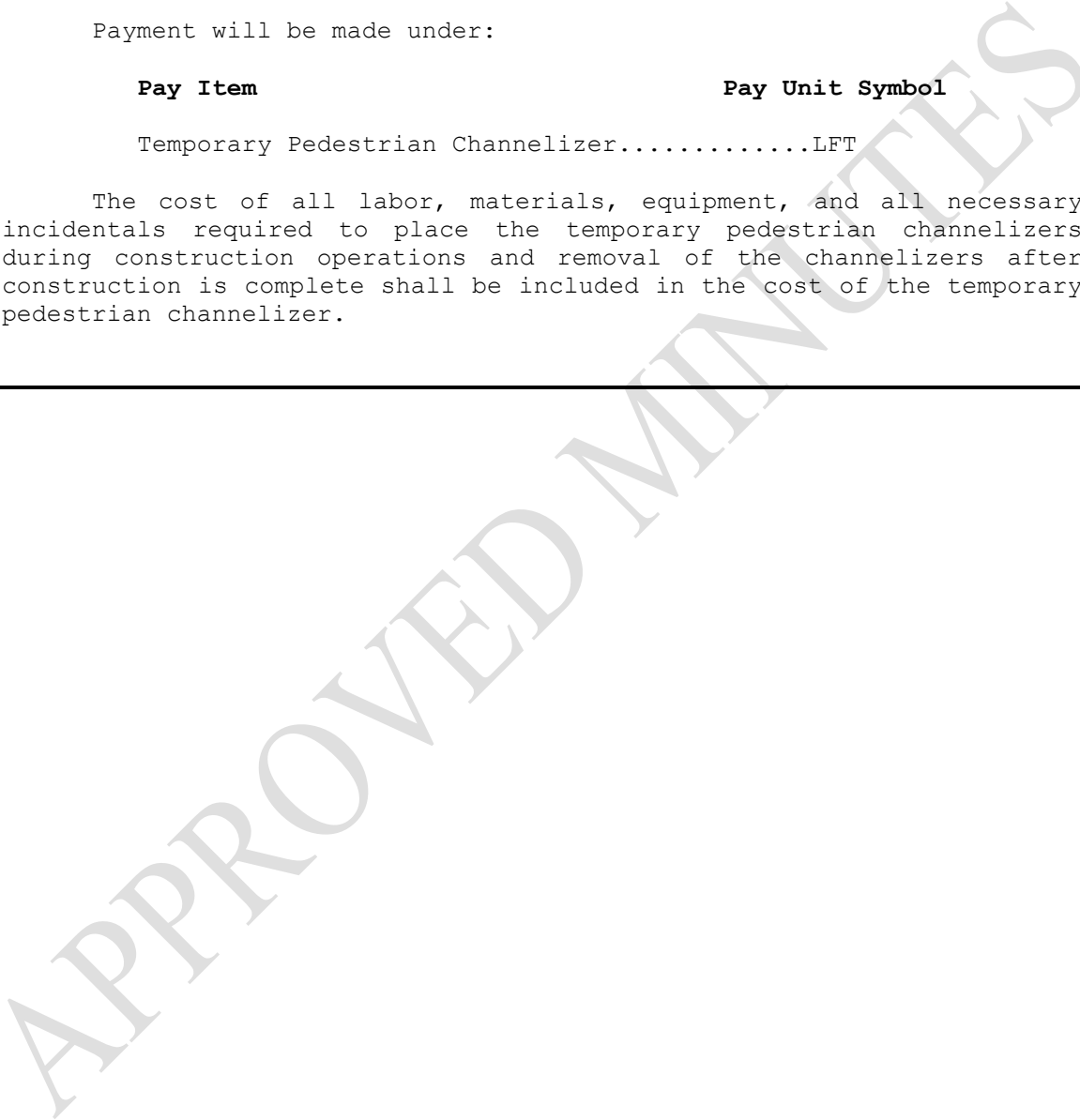

REVISION TO SPECIAL PROVISIONS AND STANDARD DRAWINGS

- 801-x-xxx TEMPORARY CURB RAMP (proposed new)
- 801-x-xxx TEMPORARY ACCESSIBLE PEDESTRIAN PATH (proposed new)
- 801-x-xxx TEMPORARY PEDESTRIAN CHANNELIZER (proposed new)
- 801-x-xxx AUDIBLE INFORMATION DEVICE (proposed new)

801-x-XXX AUDIBLE INFORMATION DEVICE

(Adopted xx-xx-xx)

**Description**

This work shall consist of installing audible information in accordance with 105.03 ~~and as shown on the plans~~. The audible information device aids movement of ~~visually disabled~~ pedestrians *with visual disabilities* at intersections and mid-block crosswalks by providing notification of sidewalk or crosswalks closures.

**Materials**

Materials shall be in accordance with 801.02 and selected from the Department's QPL of ADA Compliant Work Zone Devices.

**Construction Requirements**

The Contractor shall place the audible information device in accordance with 801.10~~7~~ or as shown on the plans.

The device shall emit a speech message to inform pedestrians of the sidewalk or crosswalk closure, guide them to the temporary crossing location and guide them along the pedestrian detour. The device shall be capable of having a 60-second message duration and shall be equipped with a built-in microphone for programming the message. The Engineer may require the Contractor to use a text to speech app for proper enunciation of the message. The device shall have a built-in speaker for broadcasting. The message for each audible information device shall be as follows:

Location Number	Location Description (e.g. See Plan Sheet x, GPS Coordinates, Intersection Quadrant, Midblock Location)	Message
1		
2		
3		
4		
5		
6		
7		
8		
9		
10		
<i>Attach additional sheets, if necessary, and use a new location number if message changes after an MOT Phase</i>		

Any adjustment in the message for an audible information device shall be as approved by the Engineer.

REVISION TO SPECIAL PROVISIONS AND STANDARD DRAWINGS

---

- 801-x-xxx TEMPORARY CURB RAMP (proposed new)
- 801-x-xxx TEMPORARY ACCESSIBLE PEDESTRIAN PATH (proposed new)
- 801-x-xxx TEMPORARY PEDESTRIAN CHANNELIZER (proposed new)
- 801-x-xxx AUDIBLE INFORMATION DEVICE (proposed new)

The device shall be activated either by built-in sensors that detect pedestrians at a minimum range of 15 ft or by a pushbutton with a locator tone. The device shall be battery powered.

The device shall be mountable on channelizing devices, pedestrian barriers, or on an independent support post.

The audible information device shall be placed at or near the closure, at locations on the pedestrian detour where a turn is required, and at other locations as shown on the plans. The audible information devices shall not reduce the effective sidewalk or pedestrian pathway width to less than 4 ft.

The final location of the audible information device at each location shall be as approved by the Engineer prior to closing the existing crosswalk or sidewalk.

**Method of Measurement**

Audible information devices will be measured by the number of locations installed.

**Basis of Payment**

The accepted quantities of audible information devices will be paid for at the contract unit price per each.

Payment will be made under:

<b>Pay Item</b>	<b>Pay Unit Symbol</b>
Audible Information Device.....	EACH

The cost of all labor, materials, equipment and all necessary incidentals required to place and maintain the audible information device during construction operations, including replacing the batteries and adjusting the message or placement at one or more locations, and removal of the device after construction is complete shall be included in the cost of the audible information device.



REVISION TO SPECIAL PROVISIONS AND STANDARD DRAWINGS

E 801-TPAR series (proposed new)

INDEX	
SHEET NO.	SUBJECT - TEMPORARY PEDESTRIAN ACCESS ROUTES
1	Index and General Notes
2	Pedestrian Detour Corner Closure
3	Pedestrian Detour Crosswalk Closure
4	Pedestrian Detour Full Block Closure
5	Pedestrian Detour Multi-Block Closure
6	Pedestrian Detour Midblock Closure
7	Pedestrian Detour Midblock Closure with Temporary Crossing
8	Pedestrian Diversion, Streetside at Intersection
9	Pedestrian Diversion, Right-of-way Side
10	Temporary Curb Ramps
11	Temporary Pedestrian Channelizers

GENERAL NOTES:

1. Signs, railings, or other objects may protrude a max. of 4 in. into the walkway clear area when located 27 in. minimum above the walkway surface.
2. Any construction signs placed in the sidewalk shall include supports with detectable edging in accordance with Part 6 of the MUTCD.
3. Audible information devices shall be a minimum of 15 ft apart and may be mounted on channelizing devices, pedestrian channelizers, or on an independent support post. Audible information devices shall not reduce the width of a temporary pedestrian access route to less than 4 ft. Placement of audible information devices shall be as shown on the plans or as directed by the Engineer.
4. Pedestrian traffic signal displays controlling closed crosswalks shall be covered or deactivated.
5. Type A flashing warning lights may be omitted on pedestrian channelizers that support signs and closed sidewalks during daytime only closures.
6. Construction signs shall not reduce the available width of a temporary pedestrian access route to less than 4 ft.

INDIANA DEPARTMENT OF TRANSPORTATION	
INDEX AND GENERAL NOTES	
SEPTEMBER 2024	
STANDARD DRAWING NO. E 801-TPAR-01	
DESIGN STANDARDS ENGINEER	DATE
CHIEF ENGINEER	DATE

REVISION TO SPECIAL PROVISIONS AND STANDARD DRAWINGS

E 801-TPAR series (proposed new, revised draft)

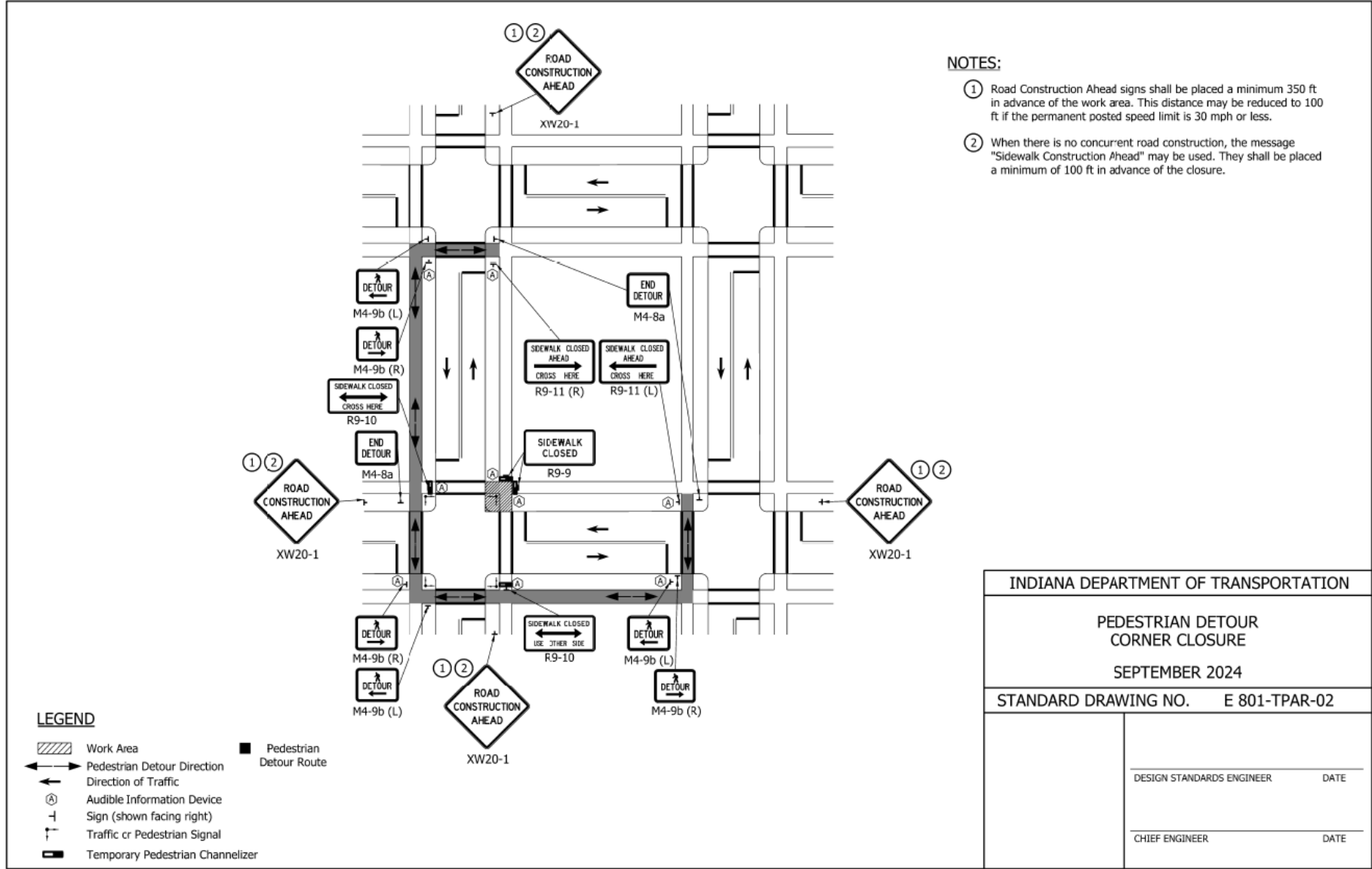

NOTES:

- ① Road Construction Ahead signs shall be placed a minimum 350 ft in advance of the work area. This distance may be reduced to 100 ft if the permanent posted speed limit is 30 mph or less.
- ② When there is no concurrent road construction, the message "Sidewalk Construction Ahead" may be used. They shall be placed a minimum of 100 ft in advance of the closure.

INDIANA DEPARTMENT OF TRANSPORTATION	
PEDESTRIAN DETOUR CORNER CLOSURE	
SEPTEMBER 2024	
STANDARD DRAWING NO.	E 801-TPAR-02
DESIGN STANDARDS ENGINEER	DATE
CHIEF ENGINEER	DATE

REVISION TO SPECIAL PROVISIONS AND STANDARD DRAWINGS

E 801-TPAR series (proposed new)

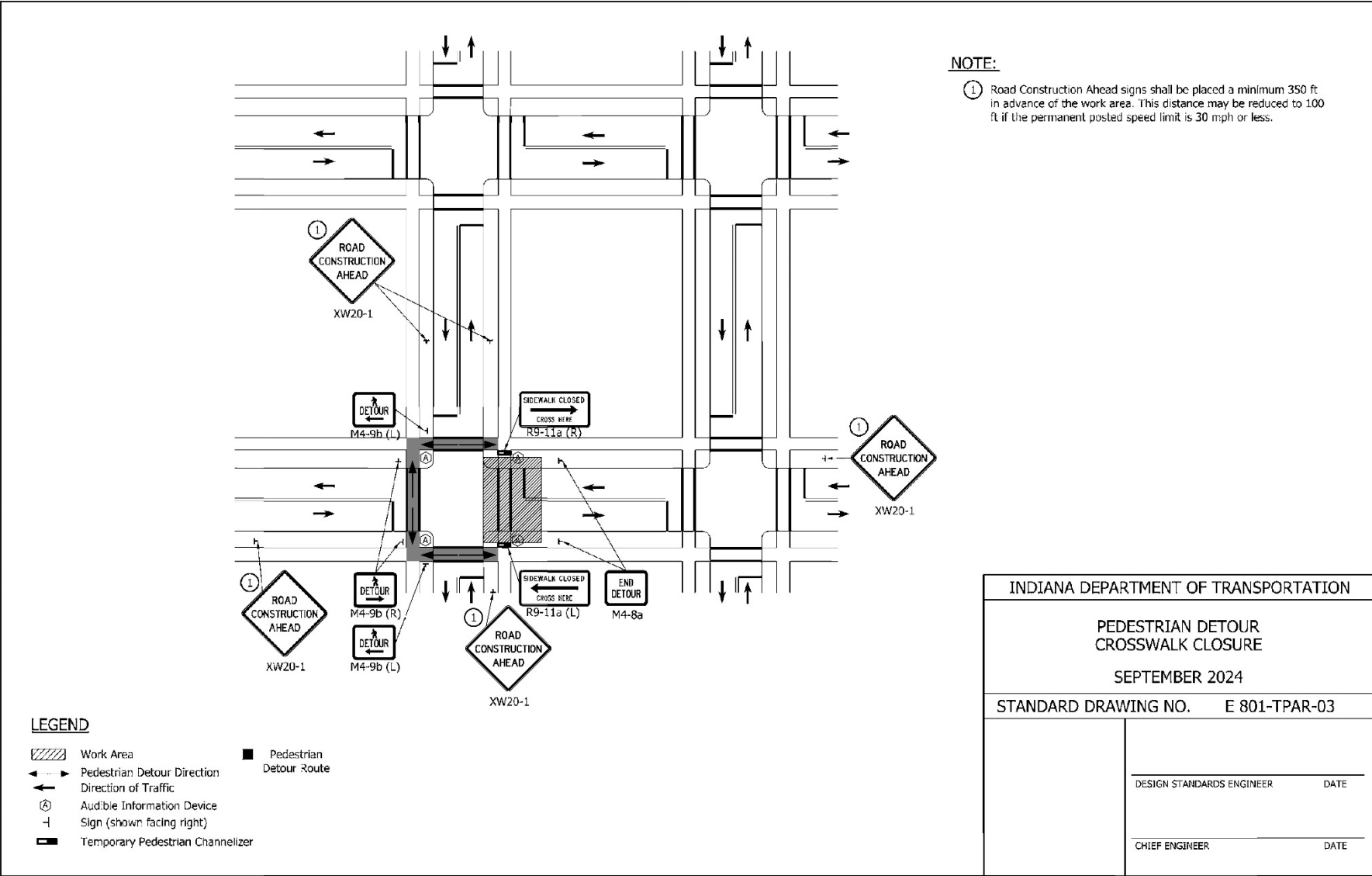



REVISION TO SPECIAL PROVISIONS AND STANDARD DRAWINGS

E 801-TPAR series (proposed new)

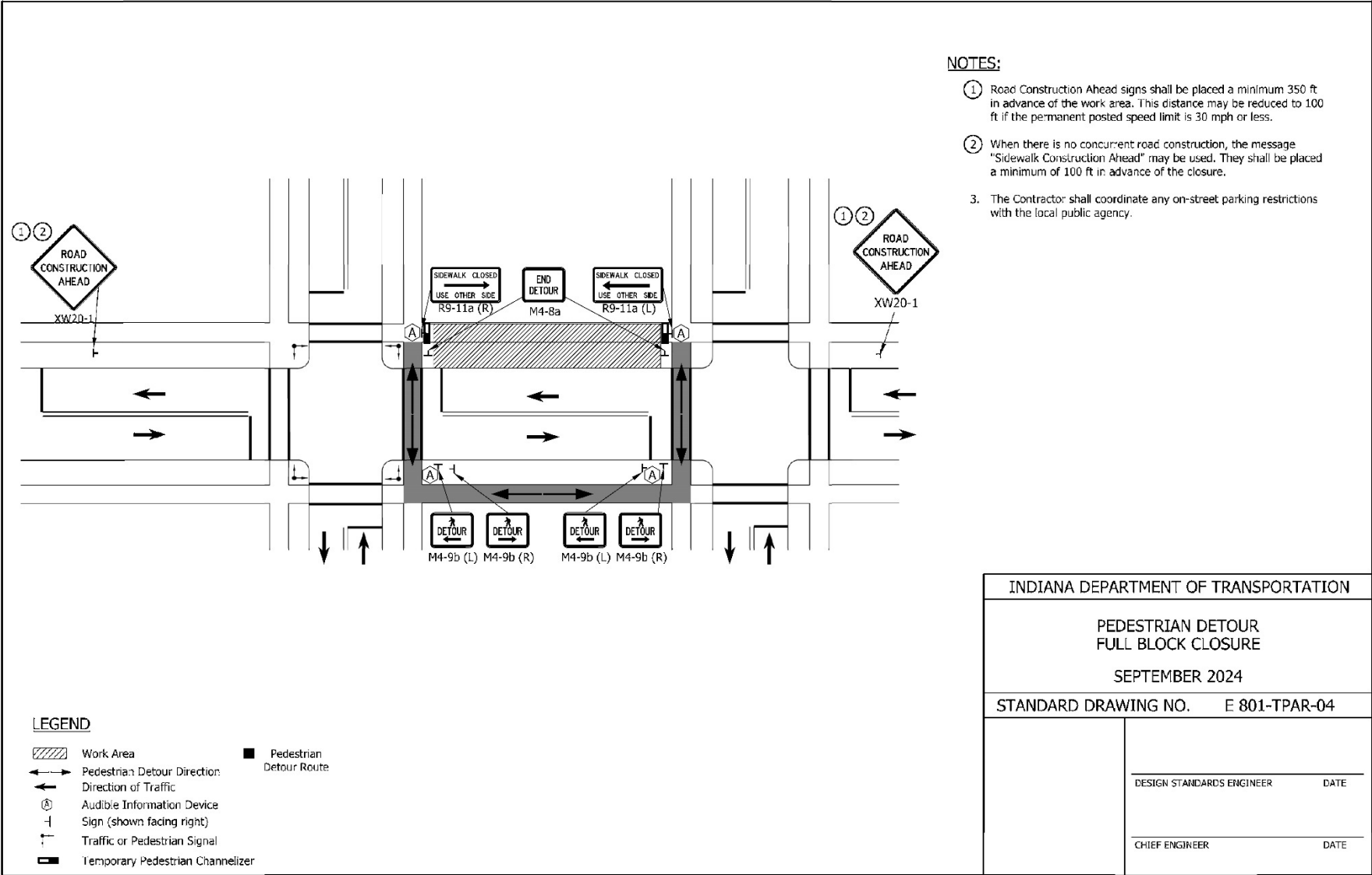

REVISION TO SPECIAL PROVISIONS AND STANDARD DRAWINGS

E 801-TPAR series (proposed new)

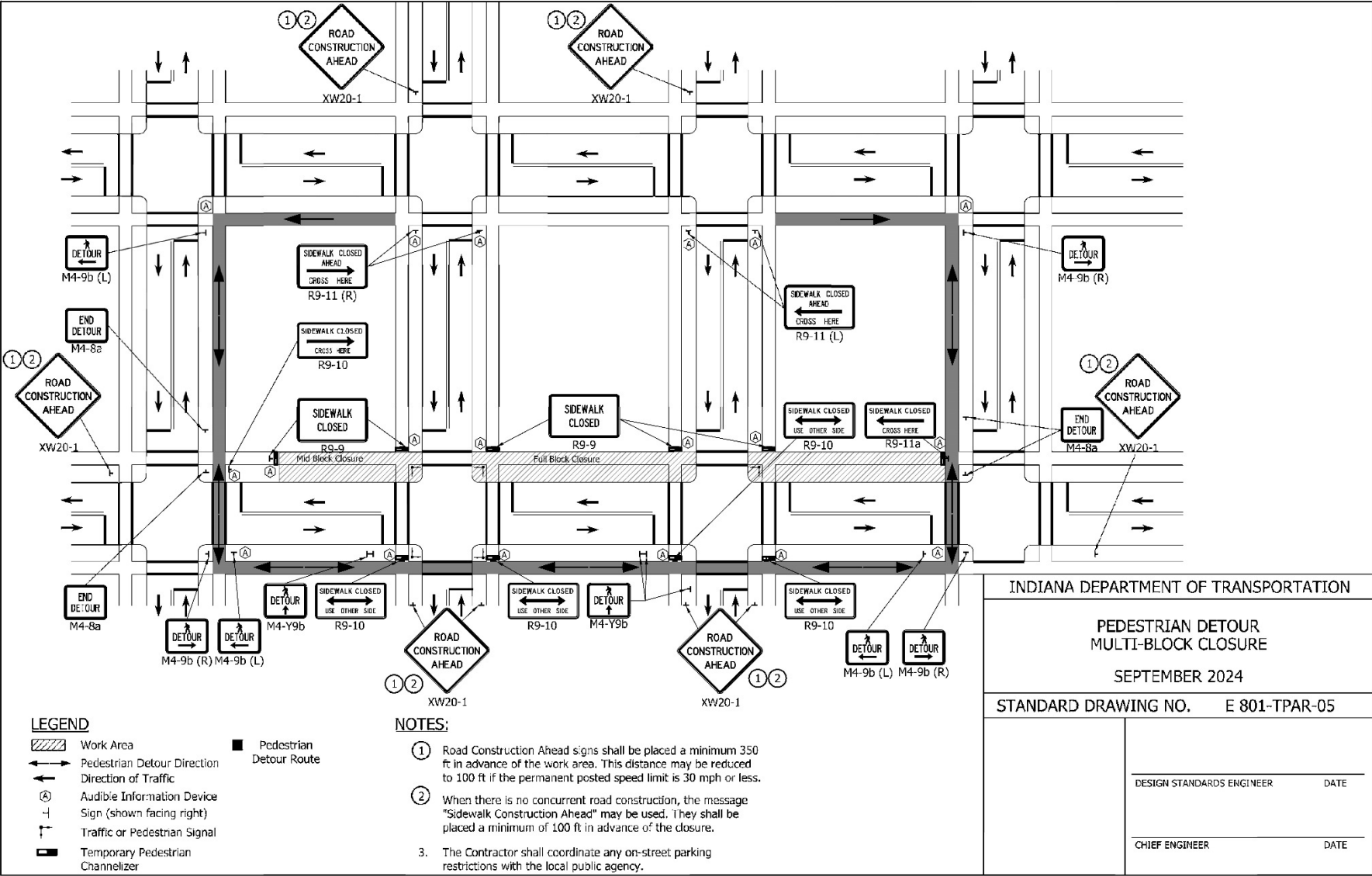

REVISION TO SPECIAL PROVISIONS AND STANDARD DRAWINGS

E 801-TPAR series (proposed new)

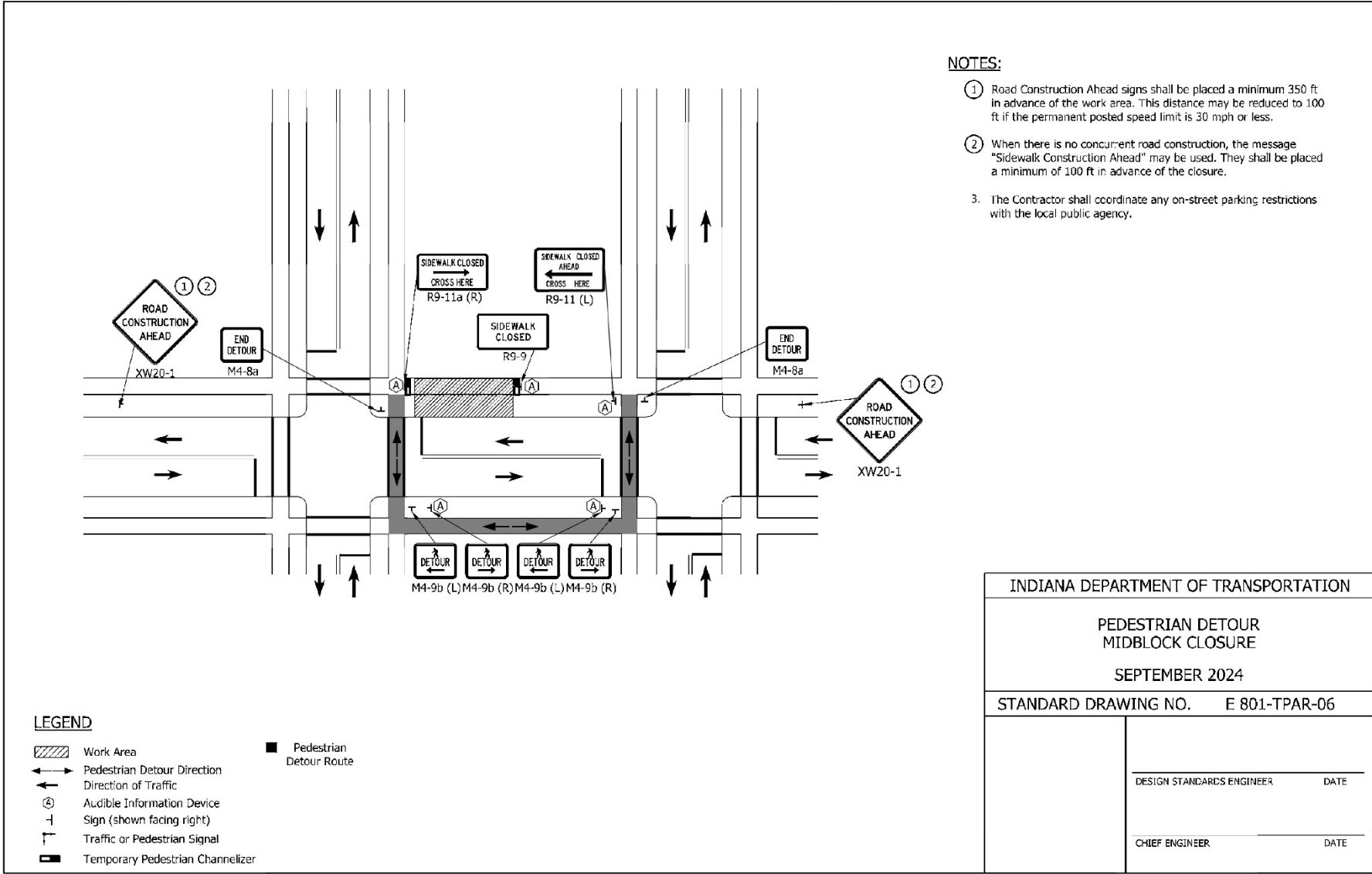

REVISION TO SPECIAL PROVISIONS AND STANDARD DRAWINGS

E 801-TPAR series (proposed new)

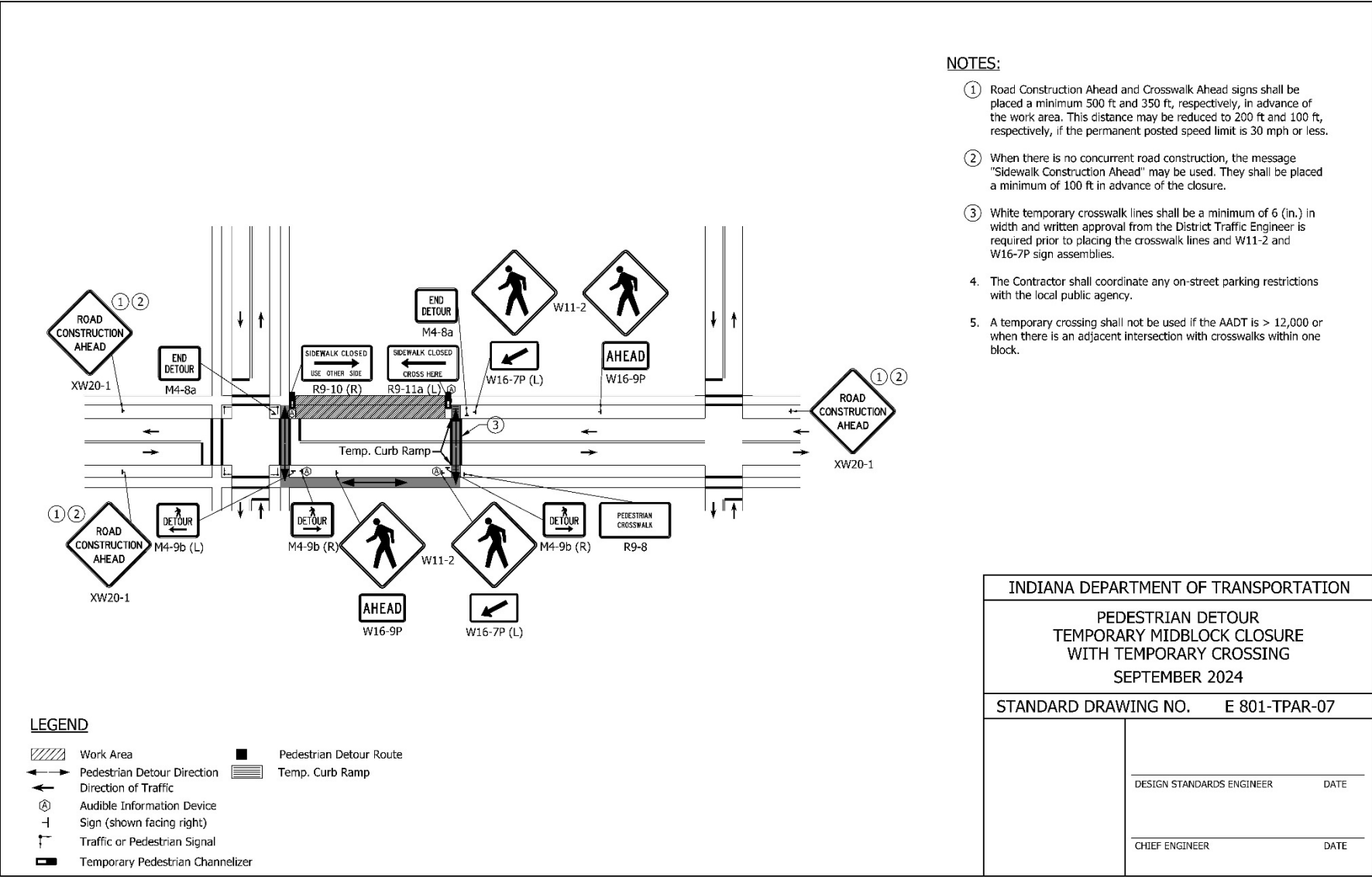

- NOTES:**
- ① Road Construction Ahead and Crosswalk Ahead signs shall be placed a minimum 500 ft and 350 ft, respectively, in advance of the work area. This distance may be reduced to 200 ft and 100 ft, respectively, if the permanent posted speed limit is 30 mph or less.
  - ② When there is no concurrent road construction, the message "Sidewalk Construction Ahead" may be used. They shall be placed a minimum of 100 ft in advance of the closure.
  - ③ White temporary crosswalk lines shall be a minimum of 6 (in.) in width and written approval from the District Traffic Engineer is required prior to placing the crosswalk lines and W11-2 and W16-7P sign assemblies.
  - 4. The Contractor shall coordinate any on-street parking restrictions with the local public agency.
  - 5. A temporary crossing shall not be used if the AADT is > 12,000 or when there is an adjacent intersection with crosswalks within one block.

REVISION TO SPECIAL PROVISIONS AND STANDARD DRAWINGS

E 801-TPAR series (proposed new)

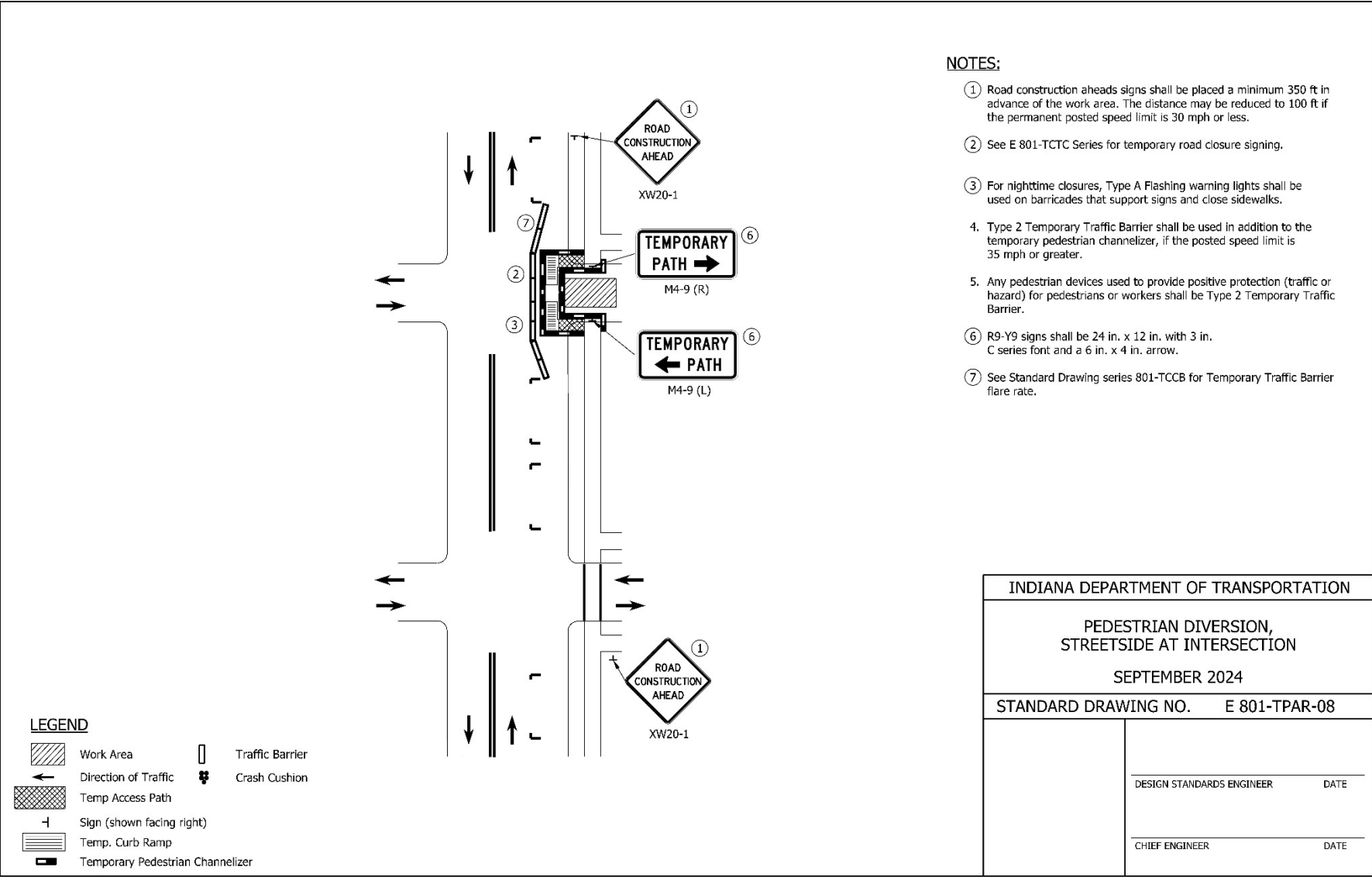

INDIANA DEPARTMENT OF TRANSPORTATION	
PEDESTRIAN DIVERSION, STREETSIDE AT INTERSECTION	
SEPTEMBER 2024	
STANDARD DRAWING NO. E 801-TPAR-08	
DESIGN STANDARDS ENGINEER	DATE
CHIEF ENGINEER	DATE

REVISION TO SPECIAL PROVISIONS AND STANDARD DRAWINGS

E 801-TPAR series (proposed new)

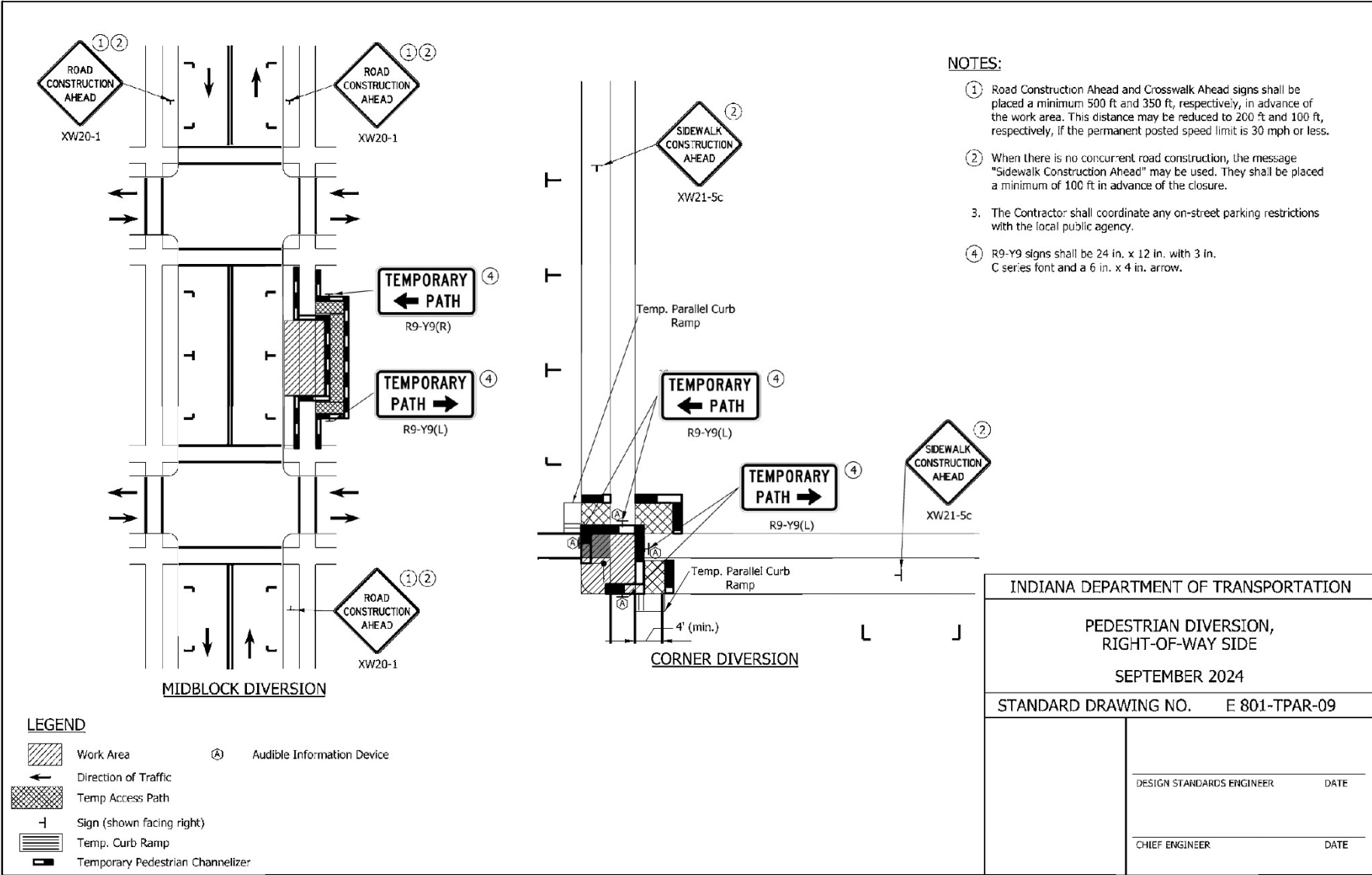

REVISION TO SPECIAL PROVISIONS AND STANDARD DRAWINGS

E 801-TPAR series (proposed new)

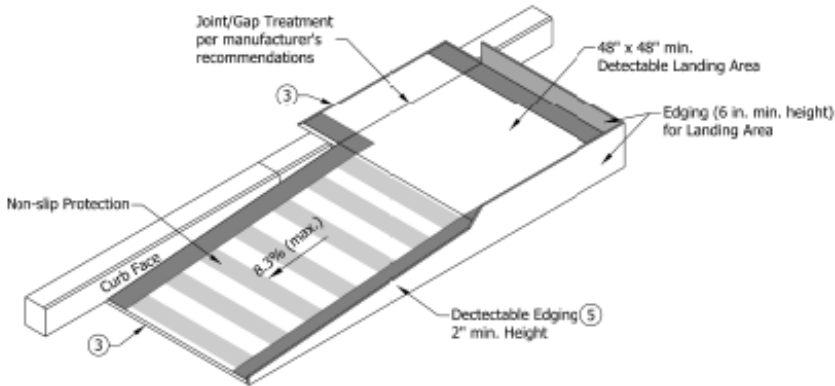

**Temporary Curb Ramp - Parallel to Curb**

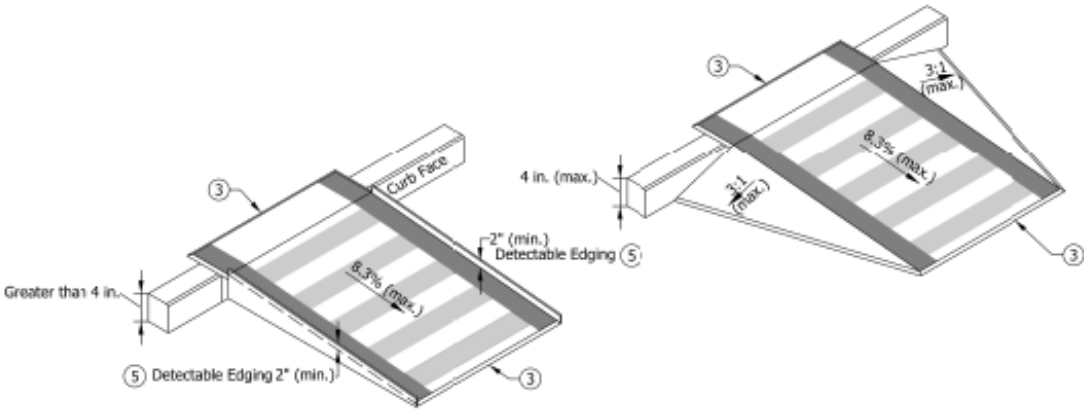

**Temporary Curb Ramp - Perpendicular to Curb**

**NOTES:**

1. Water flow in the gutter system shall be maintained.
2. Lateral joints or gaps between surfaces shall be less than 0.5 in. width.
- ③ Changes in level between surface heights shall not exceed 0.5 in. Lateral edges shall be vertical up to 0.25 in. high, and beveled at 2:1 between 0.25 in. and 0.5 in. in height
4. Handrail shall be provided along a landing area and ramp where the elevation difference between the sidewalk and the street is greater than 6.0 in.
- ⑤ A 2.0 in. detectable edge shall be provided along the entire length of the ramp where the elevation difference between the sidewalk and the street is greater than 4.0 in.
6. The rise of a single temporary curb ramp shall be no more than 30 in. If more than one temporary curb ramp is needed at a location due to the change in elevation, a minimum 5 ft landing area shall be used between curb ramps. The landing area shall have a slope of less than 2.0%.
7. The table below is for common curb heights, the curb ramp length for other curb heights shall be based on having a maximum slope of 12:1.

Curb Height (in.)	Minimum Temporary Curb Ramp Length (ft)
3	3
4	4
5	5
6	6

<b>INDIANA DEPARTMENT OF TRANSPORTATION</b>	
<b>TEMPORARY CURB RAMPS</b>	
<b>SEPTEMBER 2024</b>	
<b>STANDARD DRAWING NO.</b>	<b>E 801-TPAR-10</b>
DESIGN STANDARDS ENGINEER	DATE
CHIEF ENGINEER	DATE



REVISION TO SPECIAL PROVISIONS AND STANDARD DRAWINGS

E 801-TPAR series (proposed new)

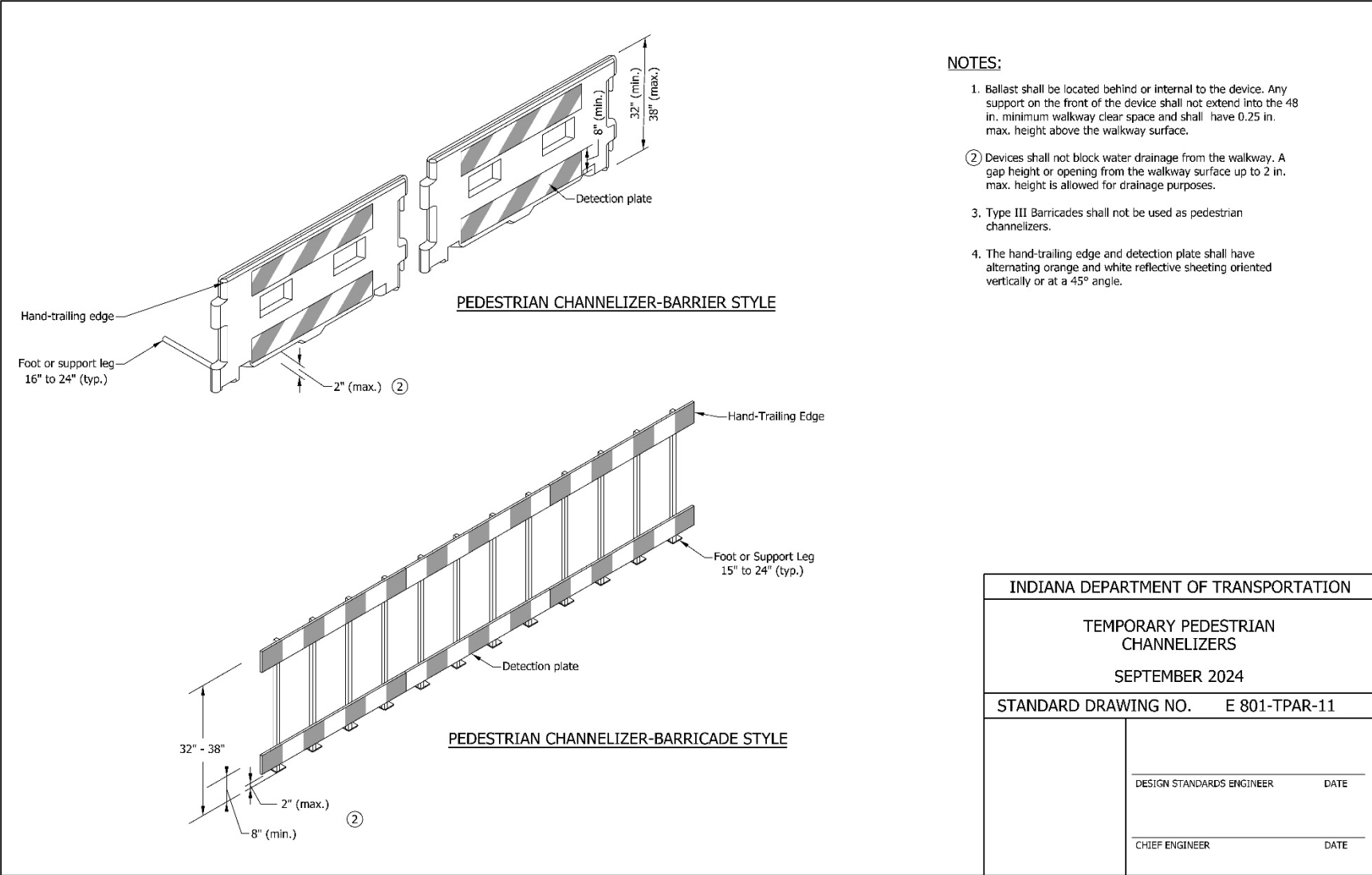

NOTES:

1. Ballast shall be located behind or internal to the device. Any support on the front of the device shall not extend into the 48 in. minimum walkway clear space and shall have 0.25 in. max. height above the walkway surface.
- ② Devices shall not block water drainage from the walkway. A gap height or opening from the walkway surface up to 2 in. max. height is allowed for drainage purposes.
3. Type III Barricades shall not be used as pedestrian channelizers.
4. The hand-trailing edge and detection plate shall have alternating orange and white reflective sheeting oriented vertically or at a 45° angle.

INDIANA DEPARTMENT OF TRANSPORTATION	
TEMPORARY PEDESTRIAN CHANNELIZERS	
SEPTEMBER 2024	
STANDARD DRAWING NO.	E 801-TPAR-11
DESIGN STANDARDS ENGINEER	DATE
CHIEF ENGINEER	DATE



COMMENTS AND ACTION

---

801-x-xxx TEMPORARY CURB RAMP (proposed new)  
801-x-xxx TEMPORARY ACCESSIBLE PEDESTRIAN PATH (proposed new)  
801-x-xxx TEMPORARY PEDESTRIAN CHANNELIZER (proposed new)  
801-x-xxx AUDIBLE INFORMATION DEVICE (proposed new)  
E 801-TPAR series (proposed new)

DISCUSSION:

This item was introduced and presented by Mr. Boruff who stated that a wide range of pedestrians may be affected by a work zone, including the young, elderly, and people with disabilities. To better provide accessible temporary facilities for pedestrians and to help satisfy federal rules on pedestrian access, there is a need to standardize details and create recurring special provisions for related devices and features.

Mr. Boruff proposed to establish a new Standard Drawing series for temporary pedestrian access routes (801-TPAR) and create recurring special provisions for [1] temporary curb ramps, [2] temporary accessible pedestrian paths, [3] temporary pedestrian channelizers, and [4] audible information devices.

Mr. Bruno pointed out that the intention is for the drawings to be RPD and not standard drawings. Ms. Mouser asked that the committee consider making these standard drawings, which would result in incorporating a design memo. Making these standard drawings might also be beneficial.

Mr. Laracuente suggested adding a note to the drawings that access to businesses and residences shall be maintained. Mr. Koch added that there is language in 107.08(e). Mr. Boruff asked Ms. Smutzer if language can be added to 107.08 for access. A small change will be made to the drawing E-801-TPAR-02 regarding the audible information devices that need to be shown, so Mr. Boruff revised his motion. Mr. Orton seconded the revised motion.

Note: Revised draft of the E 801-TRAP-02 is shown in these minutes.

There was no further discussion and this item passed as revised.

COMMENTS AND ACTION

801-x-xxx TEMPORARY CURB RAMP (proposed new)  
 801-x-xxx TEMPORARY ACCESSIBLE PEDESTRIAN PATH (proposed new)  
 801-x-xxx TEMPORARY PEDESTRIAN CHANNELIZER (proposed new)  
 801-x-xxx AUDIBLE INFORMATION DEVICE (proposed new)  
 E 801-TPAR series (proposed new)

[continued]

<p>Motion: Mr. Boruff          Second: Mr. Koch          Ayes: 10          Nays: 0          FHWA Approval: YES</p>	<p><b>Action:</b>  <input type="checkbox"/> Passed as Submitted  <input checked="" type="checkbox"/> Passed as Revised  <input type="checkbox"/> Withdrawn</p>
<p>2024 Standard Specifications Sections:          801 begin pg. 867.</p> <p>Recurring Special Provisions or Plan          Details:          (proposed new)</p> <p>Standard Drawing affected:          (proposed new)</p> <p>Design Manual Chapter:          IDM §503-3.04(13)</p> <p>GIFE Section:          22</p>	<p><input type="checkbox"/> 2026 Standard Specifications  <input checked="" type="checkbox"/> Revise Pay Items List  <input type="checkbox"/> Notification to Designers if change is <u>not</u>          addressed by RSP</p> <p><input checked="" type="checkbox"/> Create RSPs as proposed (No. 801-T-237, 801-T-238,          801-T-239, 801-T-240)          Effective: <u>September 1, 2024</u></p> <p><input type="checkbox"/> Revise RSP (No. ___)          Effective:</p> <p><input checked="" type="checkbox"/> Standard Drawings (E 801-TPAR series)          Effective: <u>September 1, 2024</u></p> <p><input type="checkbox"/> Create RPD (No. ___)          Effective:</p> <p><input checked="" type="checkbox"/> GIFE Update  <input checked="" type="checkbox"/> Frequency Manual Update  <input checked="" type="checkbox"/> SiteManager Update</p>

PROPOSAL TO STANDARDS COMMITTEE

PROBLEM(S) ENCOUNTERED: The Construction Materials component of the Build America Buy America Certification is causing confusion. By listing Manufacturer, some are listing multiple manufacturers on this certification, which is not the intent.

PROPOSED SOLUTION: Revise the Build America Buy America Certification to clear up the confusion as proposed herein.

APPLICABLE STANDARD SPECIFICATIONS: none

APPLICABLE STANDARD DRAWINGS: none

APPLICABLE DESIGN MANUAL SECTION: none

APPLICABLE SECTION OF GIFE: none

APPLICABLE RECURRING SPECIAL PROVISIONS: 106-C-277

PAY ITEMS AFFECTED: none

APPLICABLE SUB-COMMITTEE ENDORSEMENT: Ad hoc: Jim Reilman + 6 District Testing Engineers

IF APPROVED AS RECURRING SPECIAL PROVISION OR PLAN DETAILS, PROPOSED BASIS FOR USE: same BFU as it currently is.

IMPACT ANALYSIS (attach report):

Submitted By: Jim Reilman

Title: State Materials Engineer

Organization: INDOT

Phone Number: (317) 522-9692

Date: 1/12/24

IMPACT ANALYSIS REPORT CHECKLIST

*Explain the business case as to why this item should be presented to the Standards Committee for approval. Answer the following questions with Yes, No or N/A.*

Does this item appear in any other specification sections? No

Will approval of this item affect the Approved Materials List? No

Will this proposal improve:

Construction costs? N/A

Construction time? N/A

Customer satisfaction? N/A

Congestion/travel time? N/A

Ride quality? N/A

Will this proposal reduce operational costs or maintenance effort? N/A

Will this item improve safety:

For motorists? N/A

For construction workers? N/A

Will this proposal improve quality for:

Construction procedures/processes? N/A

Asset preservation? N/A

Design process? N/A

Will this change provide the contractor more flexibility? N/A

Will this proposal provide clarification for the Contractor and field personnel? Yes

Can this item improve/reduce the number of potential change orders? N/A

Is this proposal needed for compliance with:

Federal or State regulations? No

AASHTO or other design code? No

Is this item editorial? No

Provide any further information as to why this proposal should be placed on the Standards Committee meeting Agenda:

REVISION TO SPECIAL PROVISIONS

106-C-277 BUILD AMERICA, BUY AMERICA ACT REQUIREMENTS

106-C-277 BUILD AMERICA, BUY AMERICA ACT REQUIREMENTS  
[for Federal-Aid Contracts Only]

(Revised 05-20-23)

The Standard Specifications are revised as follows:

SECTION 106, BEGIN LINE 116, DELETE AND INSERT AS FOLLOWS:

**(c) Build America, Buy America Requirements**

All contracts shall be supplied with steel and iron products *and construction materials* that are produced in the United States. Steel and iron products shall comply with IC 5-16-8, 2 CFR 184, and ~~the~~ 23 CFR 635.410.

A *Build America, Buy America* Certification shall be submitted and received for each product or source of material prior to being incorporated into the contract in accordance with 916.02(e) and 916.03(e).

SECTION 106, BEGIN LINE 140, DELETE AND INSERT AS FOLLOWS:

**a. Exceptions**

The Engineer may grant specific written permission to use foreign steel or iron products when both of the following conditions apply:

- (1) The total cost of all foreign products to be used does not exceed 0.1 percent of the total Contract cost, or \$2,500, whichever is greater. The cost is the value of the product as delivered to the project.
- (2) The specified products are not produced in the United States in sufficient quantity or otherwise are not reasonably available to meet the requirements of the Contract Documents. The Engineer may require the Contractor to obtain letters from three different suppliers documenting the unavailability of a product from a domestic source if the shortage is not previously established by the Department~~The Department will request a waiver when domestic iron and steel, of satisfactory quality, are not produced in sufficient and reasonably available quantities.~~

**2. Construction Materials**

*All construction materials incorporated permanently into a contract that serve an ongoing need to the finished product shall be manufactured in the United States. All manufacturing processes for the construction materials shall occur in the United States.*

SECTION 916, BEGIN LINE 21, DELETE AND INSERT AS FOLLOWS:

**916.02 Types of Certifications**

Certifications shall be Type A, Type B, Type C, Type D, *Build America, Buy America*, or as required under other types. When specified, the type of certification

REVISION TO SPECIAL PROVISIONS

106-C-277 BUILD AMERICA, BUY AMERICA ACT REQUIREMENTS

provided for a material shall be in accordance with the Frequency Manual except as otherwise specified. Specific information and test results required in Type A, Type B, and other types of certifications will be listed in the material specifications. Sample forms for Type A, Type B, Type C, Type D, and *Build America*, Buy America certifications are shown in 916.03. Sample forms for other type certifications are shown in ITM 804.

SECTION 916, BEGIN LINE 57, DELETE AND INSERT AS FOLLOWS:

**(e) Build America, Buy America Requirement**

All steel and iron materials and products *and construction materials* used in the contract shall be certified to be in accordance with 106.01(c).

SECTION 916, BEGIN LINE 225, INSERT AS FOLLOWS:

**(e) Sample Build America, Buy America Certification Form**

**BUILD AMERICA, BUY AMERICA CERTIFICATION**

SECTION 916, BEGIN LINE 254, INSERT AS FOLLOWS:

**2. Construction Materials**

*In accordance with 106.01(c)2, I hereby certify that all construction materials and manufacturing processes for the materials listed below occurred in the United States of America or territories subject to its jurisdiction.*

<i>Material Name*</i>	<i>Quantity (units)</i>	<i>Company of Manufacture</i>
_____	_____	_____
_____	_____	_____
_____	_____	_____

\* *Identifying information shall be shown when appropriate. A separate certification is required for each different manufacturer.*

\_\_\_\_\_  
Signature of Company Official

\_\_\_\_\_  
Title

Date: \_\_\_\_\_

\_\_\_\_\_  
*Company Name*

\_\_\_\_\_  
Signature of Contractor Official

\_\_\_\_\_  
Title

Date: \_\_\_\_\_

COMMENTS AND ACTION

106-C-277 BUILD AMERICA, BUY AMERICA ACT REQUIREMENTS

DISCUSSION:

Mr. Reilman introduced and presented this item explaining that the Construction Materials component of the Build America, Buy America Certification is causing confusion. By listing Manufacturer, some are listing multiple manufacturers on this certification, which is not the intent.

Mr. Reilman proposed to revise the Build America Buy America Certification to clear up the confusion as proposed herein.

Following discussions prior to the meeting, revisions to this item are as shown, as explained by Mr. Reilman. Mr. Duncan, with FHWA, asked if a waiver will be requested. Mr. Reilman said no. Mr. Novak added that we have to comply with both federal law and state law, which are very different, and paragraph 2 applies to the state law, and there is no waiver process for state law. Mr. Reilman stated that the changes shown means that we're reverting back to what is currently shown in the 2024 spec book.

Mr. Reilman revised his motion, which was seconded by Mr. Boruff.

There was no further discussion and this item passed as revised.

<p>Motion: Mr. Reilman                  Second: Mr. Dave                  Ayes: 10                  Nays: 0                  FHWA Approval: YES</p>	<p><b>Action:</b>  <input type="checkbox"/> Passed as Submitted  <input checked="" type="checkbox"/> Passed as Revised  <input type="checkbox"/> Withdrawn</p>
<p>2024 Standard Specifications Sections:                  106 pg. 65; 916 pg. 1129.</p> <p>Recurring Special Provisions or Plan                  Details:  <a href="#">106-C-277 BUILD AMERICA, BUY AMERICA                  ACT REQUIREMENTS</a></p> <p>Standard Drawing affected:                  NONE</p> <p>Design Manual Chapter:                  NONE</p> <p>GIFE Section:                  NONE</p>	<p>2026 Standard Specifications  <input type="checkbox"/> Revise Pay Items List  <input type="checkbox"/> Notification to Designers if change is <u>not</u>                  addressed by RSP</p> <p><input type="checkbox"/> Create RSP (No. __)                  Effective:</p> <p><input checked="" type="checkbox"/> Revise RSP (No. <u>106-C-277</u>)                  Effective: <u>September 1, 2024</u></p> <p><input type="checkbox"/> Standard Drawing                  Effective:</p> <p><input type="checkbox"/> Create RPD (No. __)                  Effective:</p> <p><input type="checkbox"/> GIFE Update  <input type="checkbox"/> Frequency Manual Update  <input type="checkbox"/> SiteManager Update</p>

PROPOSAL TO STANDARDS COMMITTEE

PROBLEM(S) ENCOUNTERED: The 501 specification requires that mixes be optimized in accordance with the Tarantula Curve developed by Dr. Tyler Ley at Oklahoma State University. The "box test" is a companion method to the Tarantula Curve that validates the workability of the proposed mix. The box test is not required in the current specification.

PROPOSED SOLUTION: The box test will be added to the trial batch requirements for 501 PCCP mix designs. Note that the box test is an evaluation tool and involves subjectivity. It is intended to be an aid in evaluating mixes prior to use and will not be used alone as a pass/fail test.

APPLICABLE STANDARD SPECIFICATIONS: 501.06

APPLICABLE STANDARD DRAWINGS: none

APPLICABLE DESIGN MANUAL SECTION: none

APPLICABLE SECTION OF GIFE: none

APPLICABLE RECURRING SPECIAL PROVISIONS: 501-R-769

PAY ITEMS AFFECTED: none

APPLICABLE SUB-COMMITTEE ENDORSEMENT: INDOT-IACPA working committee

IF APPROVED AS RECURRING SPECIAL PROVISION OR PLAN DETAILS, PROPOSED BASIS FOR USE: (same as existing BFU) Required for all contracts with any 501 or 706 pay items.

IMPACT ANALYSIS (attach report):

Submitted By: Jim Reilman

Title: State Materials Engineer

Organization: INDOT

Phone Number: (317) 522-9692

Date: 1/10/2024



IMPACT ANALYSIS REPORT CHECKLIST

*Explain the business case as to why this item should be presented to the Standards Committee for approval. Answer the following questions with Yes, No or N/A.*

Does this item appear in any other specification sections? No

Will approval of this item affect the Approved Materials List? No

Will this proposal improve:

Construction costs? N/A

Construction time? N/A

Customer satisfaction? N/A

Congestion/travel time? N/A

Ride quality? N/A

Will this proposal reduce operational costs or maintenance effort? N/A

Will this item improve safety:

For motorists? N/A

For construction workers? N/A

Will this proposal improve quality for:

Construction procedures/processes? Yes

Asset preservation? Yes

Design process? N/A

Will this change provide the contractor more flexibility? N/A

Will this proposal provide clarification for the Contractor and field personnel? Yes

Can this item improve/reduce the number of potential change orders? N/A

Is this proposal needed for compliance with:

Federal or State regulations? No

AASHTO or other design code? No

Is this item editorial? No

Provide any further information as to why this proposal should be placed on the Standards Committee meeting Agenda:

REVISION TO SPECIAL PROVISION

---

501-R-769 QC/QA PORTLAND CEMENT CONCRETE PAVEMENT, PCCP

501-R-769 QC/QA PORTLAND CEMENT CONCRETE PAVEMENT, PCCP

(Adopted 10-19-23)

The Standard Specifications are revised as follows:

SECTION 501, BEGIN LINE 23, DELETE AND INSERT AS FOLLOWS:

An ACI-~~e~~Certified ~~e~~Concrete ~~Field~~ ~~Testing~~ ~~Technician~~, ~~g~~Grade I, shall be on site to direct all sampling and testing.

SECTION 501, BEGIN LINE 199, DELETE AND INSERT AS FOLLOWS:

**501.06 Trial Batch**

A trial batch shall be produced and tested by the Contractor's ACI-~~e~~Certified *Concrete Field Testing* ~~Technician~~, *Grade I*, to verify that the CMDS meets the concrete mix criteria. *An ACI-Certified Concrete Field Testing Technician, Grade I, shall be on site to direct all sampling and testing.* Concrete produced at a plant shall be batched within the proportioning tolerances of 508.02(b). Concrete batched in a laboratory shall be in accordance with ASTM C192. The Engineer will test the trial batch and provide the Contractor with the results. The trial batch shall be of sufficient quantity to allow the Contractor and the Engineer to perform all required tests from the same batch. Trial batch concrete shall not be used for more than one test, except the concrete used for the unit weight may be used to conduct the air content test. The air content shall be 5.5% to 10.0%. The plastic unit weight shall be within  $\pm 3.0\%$  from the target plastic unit weight of the CMDS. The water/cementitious ratio shall be within  $\pm 0.015$  of the target value of the CMDS and shall not exceed the maximum amount allowed for the appropriate mix in accordance with 501.05. The flexural strength shall be determined by averaging a minimum of two beam breaks and shall be a minimum of 570 psi.

*The box test shall be performed in accordance with AASHTO T 396. The ~~box test~~ result shall be ~~two based on the Box Test Ranking Scale~~. The ~~box test~~ is not intended as a ~~standalone basis for rejection of the trial batch~~ overall void rating shall be 2.25 or less. If the overall void rating is greater than 2.25, the trial batch may be subject to rejection.*

COMMENTS AND ACTION

---

501-R-769 QC/QA PORTLAND CEMENT CONCRETE PAVEMENT, PCCP

DISCUSSION:

This item was introduced and presented by Mr. Reilman who stated that the 501 specification requires that mixes be optimized in accordance with the Tarantula Curve developed by Dr. Tyler Ley at Oklahoma State University. The "box test" is a companion method to the Tarantula Curve that validates the workability of the proposed mix. The box test is not yet required in the current specification.

Mr. Reilman proposed to add the box test to the trial batch requirements for 501 PCCP mix designs. Note that the box test is an evaluation tool and involves subjectivity. It is intended to be an aid in evaluating mixes prior to use and will not be used alone as a pass/fail test.

Following discussions prior to the meeting, revisions to this item are as shown, which were explained by Mr. Reilman. Mr. Jacobs asked about the AASHTO T 396 not having the IA program and said that AASHTO T 396 wasn't included in the ACI level one. Is it any concern that neither of our qualification programs qualify the contractor or verify that the individual is performing a test accurately?

Mr. Nelson responded that some of the contractors are already running it. Mr. Nelson added that we'll have to follow up and move this into the program to get more people up to speed on it, but I don't think it limits us from being able to do it for now. It's going to be locked down to very few folks who will actually be performing it. And the contractor will perform the test. Our Materials and Test will be there, early on, to make sure we're all on the same page and when we use it.

Mr. Bazlamit asked about the criteria for a mix that you would consider to be passing or failing if the box is not used in that regard? Mr. Nelson responded that if it doesn't ultimately make the 2.25, we would fail it and that's why the word "may" is in there, because the whole assessing each side visually, there's a little bit of subjectivity to it, so we took that language out of there about the stand alone because it did take it out of our hands a little bit, but as it's written now if everybody agrees that it's not a 2.25 in the end it could be rejected.

Mr. Reilman revised his motion. Mr. Boruff seconded.

There was no further discussion and this item passed as revised.

COMMENTS AND ACTION

501-R-769 QC/QA PORTLAND CEMENT CONCRETE PAVEMENT, PCCP

[continued]

Motion: Mr. Reilman Second: Mr. Dave Ayes: 10 Nays: 0 FHWA Approval: YES	<b>Action:</b> <input type="checkbox"/> Passed as Submitted <input checked="" type="checkbox"/> Passed as Revised <input type="checkbox"/> Withdrawn
2024 Standard Specifications Sections: 501 pg. 407.	<input checked="" type="checkbox"/> 2026 Standard Specifications <input type="checkbox"/> Revise Pay Items List <input type="checkbox"/> Notification to Designers if change is <u>not</u> addressed by RSP
Recurring Special Provisions or Plan Details: <a href="#">501-R-769 QC/QA PORTLAND CEMENT CONCRETE PAVEMENT, PCCP</a>	<input type="checkbox"/> Create RSP (No. __) Effective:
Standard Drawing affected: NONE	<input checked="" type="checkbox"/> Revise RSP (No. <u>501-R-769</u> ) Effective: <u>September 1, 2024</u>
Design Manual Chapter: NONE	<input type="checkbox"/> Standard Drawing Effective:
GIFE Section: NONE	<input type="checkbox"/> Create RPD (No. __) Effective:  <input type="checkbox"/> GIFE Update <input type="checkbox"/> Frequency Manual Update <input type="checkbox"/> SiteManager Update

PROPOSAL TO STANDARDS COMMITTEE

PROBLEM(S) ENCOUNTERED: Longitudinal tining on concrete paving contracts has been constructed with the tining having some wander (not being straight).

PROPOSED SOLUTION: Add a requirement that the mechanical device used for tining have automated elevation and steering controls which will apply the same tine pressure across the full width and minimize tine wandering.

APPLICABLE STANDARD SPECIFICATIONS: 508

APPLICABLE STANDARD DRAWINGS: None

APPLICABLE DESIGN MANUAL SECTION: None

APPLICABLE SECTION OF GIFE: None

APPLICABLE RECURRING SPECIAL PROVISIONS: 504-R-757

PAY ITEMS AFFECTED:

APPLICABLE SUB-COMMITTEE ENDORSEMENT: Ad Hoc: Tommy Nantung, Michael Nelson, Jim Reilman

IF APPROVED AS RECURRING SPECIAL PROVISION OR PLAN DETAILS, PROPOSED BASIS FOR USE: same as exists for 504-R-757

IMPACT ANALYSIS (attach report):

Submitted By: Jim Reilman

Title: State Materials Engineer

Organization: INDOT

Phone Number: (317) 522-9692

Date: 1/22/24

IMPACT ANALYSIS REPORT CHECKLIST

*Explain the business case as to why this item should be presented to the Standards Committee for approval. Answer the following questions with Yes, No or N/A.*

Does this item appear in any other specification sections? No

Will approval of this item affect the Approved Materials List? No

Will this proposal improve:

Construction costs? N/A

Construction time? N/A

Customer satisfaction? Yes

Congestion/travel time? N/A

Ride quality? Yes

Will this proposal reduce operational costs or maintenance effort? N/A

Will this item improve safety:

For motorists? Yes

For construction workers? N/A

Will this proposal improve quality for:

Construction procedures/processes? Yes

Asset preservation? N/A

Design process? N/A

Will this change provide the contractor more flexibility? N/A

Will this proposal provide clarification for the Contractor and field personnel? Yes

Can this item improve/reduce the number of potential change orders? N/A

Is this proposal needed for compliance with:

Federal or State regulations? No

AASHTO or other design code? No

Is this item editorial? No

Provide any further information as to why this proposal should be placed on the Standards Committee meeting Agenda:

REVISION TO SPECIAL PROVISION  
504-R-757 LONGITUDINAL TINING

504-R-757 LONGITUDINAL TINING

(Adopted 04-20-23)

The Standard Specifications are revised as follows:

SECTION 504, BEGIN LINE 15, DELETE AND INSERT AS FOLLOWS:

**504.03 Finishing and Surface Texturing**

**(a) Finishing**

PCCP shall be finished with equipment in accordance with 508.04. The operations shall be controlled so that an excess of mortar and water is not worked to the top. Long-handled floats may be used to smooth and fill in open textured areas in the PCCP.

Hand methods of finishing may be used when finishing equipment breaks down or in tight working areas where field conditions limit the use of mechanical devices. Hand placed concrete shall be further finished by means of a longitudinal float or a transverse smoothing float in accordance with 508.08(a).

The edges of formed PCCP adjacent to HMA or compacted aggregate shall be tooled. A continuous radius with a uniform smooth dense mortar finish shall be produced.

~~The PCCP surface shall be textured with a double thickness burlap drag or a minimum 4 ft wide turf drag.~~

~~The textured surface of PCCP shall be tined, unless otherwise specified. Tining shall consist of transverse grooves that are between 3/32 and 1/8 in. in width, between 1/8 and 3/16 in. in depth, and be spaced as follows: 5/8 in., 1 in., 7/8 in., 5/8 in., 1 1/4 in., 3/4 in., 1 in., 1 in., 1 in., 1 in., 3/4 in., 7/8 in., 1 3/4 in., 7/8 in., 3/8 in., 1 in., 1 in., 1 1/4 in., 1 1/2 in., 7/8 in., 3/4 in., 7/8 in., 1 in., 7/8 in., 1 in. The grooving pattern shall be repeated across the pavement. The tining grooves shall be formed in the plastic concrete without tearing the surface and without bringing pieces of the coarse aggregate to the top of the surface.~~

~~Texturing and curing operations may be performed by a single machine subject to satisfactory performance.~~

~~Areas of PCCP which are not finished in accordance with these requirements shall be corrected by retexturing.~~

~~Retexturing shall consist of cutting longitudinal or transverse grooves in the PCCP surface by means of saw blades or other approved devices. The grooves shall be spaced 3/4 in. center to center and be 1/8 in. in width and depth. Alternative patterns may be used, subject to approval. The PCCP surface, after cutting, shall not be polished.~~

**(b) Surface Texturing**

*The PCCP surface shall be textured with a double thickness burlap drag or a minimum 4 ft wide turf drag followed by tining oriented either longitudinal or transverse to the direction of travel as specified herein, all before the PCCP permanently sets. The PCCP surface of mailbox approaches and private and commercial driveways shall be broom finished before the PCCP permanently sets.*

*Tining the textured surface shall be completed using a mechanical device in accordance with 508.06. The Contractor shall oversee the tining operation to ensure the forming of straight, uniform grooves in the textured, plastic PCCP surface without tearing the concrete surface, without allowing the tine groove edges to slump at the edges, and without bringing pieces of the coarse aggregate to the top of the PCCP surface. Wander and overlap of the tining, and any wavy pattern in the tining shall be prevented. Presence of wander, overlap, or wavy pattern in the tining will be cause for retexturing.*

*For tight working areas, form work, and where field conditions such as small or irregularly shaped areas limit the use of mechanical devices, as determined by the Engineer, the Contractor may request to use a hand tool that is in accordance with 508.06 and has tines and spacing in accordance with 504.03(b)1 or 2 below, as applicable for the application.*

*Texturing and curing operations may be performed by a single machine subject to satisfactory performance.*

### **1. Longitudinal Tining**

*Tining shall be in the longitudinal direction, parallel with the direction of travel, on all PCCP that is uniform in width, including mainline and shoulders. Tining shall be completed using a mechanical device in accordance with 508.06 that has 1/8 in. wide tines, spaced at 3/4 in. center-to-center, and produces a uniform, nominal depth tine groove 1/8 in.  $\pm$  1/16 in. deep in the plastic PCCP. The mechanical device shall be able to tine the full width of the PCCP in one operation. Tining shall be completed prior to the application of curing materials. String line or other controls for line and grade shall be used to ensure straight tining parallel with the direction of travel. Tining shall not be performed within 3 in. of pavement edges or longitudinal joints.*

### **2. Transverse Tining**

*Tining shall be in the transverse direction, perpendicular to the direction of travel, on PCCP on all approaches, ramps, tapered areas, and gore areas. Tining shall be completed using a mechanical device in accordance with 508.06 that has 1/8 in. wide tines, spaced center-to-center as follows: 3/8 in., 9/16 in., 5/8 in., 7/16 in., 3/8 in., 1/2 in., 9/16 in., 5/8 in., 7/16 in., 3/8 in., 13/16 in., 1/2 in., and produces a uniform, nominal depth tine groove 1/8 in.  $\pm$  1/16 in. deep in the plastic PCCP. The tining pattern shall be repeated across the PCCP surface perpendicular to the direction of travel.*

### **(c) Retexturing**

*Areas of PCCP which are not finished and textured in accordance with the requirements herein shall be corrected by retexturing. Retexturing shall be done in the*



REVISION TO SPECIAL PROVISION

504-R-757 LONGITUDINAL TINING

*same longitudinal or transverse direction as the orientation of the existing tining. It shall consist of cutting longitudinal or transverse grooves in the PCCP surface by means of saw blades or other approved devices. The grooves shall be spaced in accordance with 504.03(b)1 or 2 above as appropriate. The PCCP surface, after cutting, shall not be polished.*

**504.04 Curing**

Curing materials shall be applied to exposed surfaces and sides of newly placed PCCP within 30 minutes after the finishing operations have been completed, or as soon as marring of the concrete does not occur. Paving operations shall be immediately suspended if sufficient curing materials are not available on site.

SECTION 504, BEGIN LINE 127, INSERT AS FOLLOWS:

**504.06 Basis of Payment**

The cost of finishing the PCCP surface furnishing and placing curing materials shall be included in the cost of the PCCP. *Retexturing shall be at no additional cost to the Department.*

SECTION 508, BEGIN LINE 217, DELETE AND INSERT AS FOLLOWS:

**508.06 ~~Texturing~~Tining Equipment**

~~Mechanical texturing equipment~~*The mechanical device shall be capable of forming transverse have horizontal and vertical automated elevation and steering controls to ensure the forming of straight grooves of uniform depth and alignment in the plastic PCCP, without tearing the surface. The ~~texturing comb~~mechanical device shall have a single row of steel tines spaced as specified.*

Hand tools consisting of fluted floats, rakes with spring steel tines, or finned floats with a single row of fins shall produce grooves which conform to the same requirements as those specified for the grooves formed by the mechanical ~~equipment~~*device.*

COMMENTS AND ACTION

504-R-757 LONGITUDINAL TINING

DISCUSSION:

Mr. Reilman introduced and presented this item, stating that longitudinal tining on concrete paving contracts has been constructed with the tining having some wander (not being straight).

Mr. Reilman proposed to add a requirement that the mechanical device used for tining have automated elevation and steering controls which will apply the same tine pressure across the full width and minimize tine wandering.

Mr. Koch mentioned that the proposed language mirrors 508.04, line 103, slipform paver requirements; automated elevation & steering. For paving, the results of the Contractor’s efforts include a smoothness requirement. No objections to the proposal, not sure if outcomes will change as previous language included automated grade control using string line or similar. A tining machine may be able to provide uniform pressure to the cutting tines yet the firmness of the concrete will determine relative depth, and automation can be overridden. Can the IRI sense horizontal tire wander?

Mr. Novak responded that the inertial profiler uses a laser and filter that accounts for tining variations. So while it can be sensed, it is removed from the IRI calculation behind the scenes. Mr. Novak added that it is not desirable to correct pavement for smoothness after tining, at least not for any sizable area.

There was no further discussion and this item passed as submitted.

<p>Motion: Mr. Reilman                  Second: Mr. Dave                  Ayes: 10                  Nays: 0                  FHWA Approval: YES</p>	<p><b>Action:</b>  <input checked="" type="checkbox"/> Passed as Submitted  <input type="checkbox"/> Passed as Revised  <input type="checkbox"/> Withdrawn</p>
<p>2024 Standard Specifications Sections:                  504 begin pg. 441 and 508 begin pg.                  Recurring Special Provisions or Plan                  Details:  <a href="#">504-R-757 LONGITUDINAL TINING</a></p> <p>Standard Drawing affected:                  NONE</p> <p>Design Manual Chapter:                  NONE</p> <p>GIFE Section:                  NONE</p>	<p><input checked="" type="checkbox"/> 2026 Standard Specifications  <input type="checkbox"/> Revise Pay Items List  <input type="checkbox"/> Notification to Designers if change is <u>not</u>                  addressed by RSP</p> <p><input type="checkbox"/> Create RSP (No. __)                  Effective:</p> <p><input checked="" type="checkbox"/> Revise RSP (No. <u>504-R-757</u>)                  Effective: <u>September 1, 2024</u></p> <p><input type="checkbox"/> Standard Drawing                  Effective:</p> <p><input type="checkbox"/> Create RPD (No. __)                  Effective:</p> <p><input type="checkbox"/> GIFE Update  <input type="checkbox"/> Frequency Manual Update  <input type="checkbox"/> SiteManager Update</p>

PROPOSAL TO STANDARDS COMMITTEE

PROBLEM(S) ENCOUNTERED: Previous revisions to the 502 section have created strength targets that are excessive for curbing and approaches.

PROPOSED SOLUTION: Revise the 605 and 610 sections to revert the strength target back to 550 psi at 28 days instead of the existing 570 psi at 7 days.

APPLICABLE STANDARD SPECIFICATIONS: 605 and 610

APPLICABLE STANDARD DRAWINGS: none

APPLICABLE DESIGN MANUAL SECTION: none

APPLICABLE SECTION OF GIFE: none

APPLICABLE RECURRING SPECIAL PROVISIONS: create new RSP

PAY ITEMS AFFECTED: none

APPLICABLE SUB-COMMITTEE ENDORSEMENT: INDOT-IRMCA working committee (10/26/23)

IF APPROVED AS RECURRING SPECIAL PROVISION OR PLAN DETAILS, PROPOSED BASIS FOR USE: All contracts with 605 or 610 pay items.

IMPACT ANALYSIS (attach report):

Submitted By: Jim Reilman

Title: State Materials Engineer

Organization: INDOT

Phone Number: (317) 522-9692

Date: 1/10/2024

IMPACT ANALYSIS REPORT CHECKLIST

*Explain the business case as to why this item should be presented to the Standards Committee for approval. Answer the following questions with Yes, No or N/A.*

Does this item appear in any other specification sections? No

Will approval of this item affect the Approved Materials List? No

Will this proposal improve:

Construction costs? N/A

Construction time? N/A

Customer satisfaction? N/A

Congestion/travel time? N/A

Ride quality? N/A

Will this proposal reduce operational costs or maintenance effort? N/A

Will this item improve safety:

For motorists? N/A

For construction workers? N/A

Will this proposal improve quality for:

Construction procedures/processes? N/A

Asset preservation? Yes

Design process? N/A

Will this change provide the contractor more flexibility? Yes

Will this proposal provide clarification for the Contractor and field personnel? Yes

Can this item improve/reduce the number of potential change orders? N/A

Is this proposal needed for compliance with:

Federal or State regulations? No

AASHTO or other design code? No

Is this item editorial? No

Provide any further information as to why this proposal should be placed on the Standards Committee meeting Agenda:

REVISION TO 2024 STANDARD SPECIFICATIONS

- SECTION 605 – CURBING
- 605.02 Materials
- SECTION 610 – APPROACHES AND CROSSOVERS
- 610.02 Materials

The Standard Specifications are revised as follows:

SECTION 605, BEGIN LINE 8, DELETE AND INSERT AS FOLLOWS:

**605.02 Materials**

Materials shall be in accordance with the following:

Coarse Aggregate, Class D or Higher, Size No. 53 .....	904.03
<del>Concrete .....</del>	<del>502</del>
Joint Materials .....	906
Joint Mortar .....	907.12
Precast Concrete Curbing .....	905.04
Reinforcing Bars .....	910.01

*Concrete shall be in accordance with 502 except the minimum modulus of rupture shall be 550 psi at 28 days.*

SECTION 610, BEGIN LINE 12, DELETE AND INSERT AS FOLLOWS:

**610.02 Materials**

Materials shall be in accordance with the following:

Aggregate Base .....	301.02
Geogrid, Type IB .....	918.05
HMA .....	402.03
<del>PCCP .....</del>	<del>502.02</del>
Prime Coat .....	405.02
Seal Coat .....	404
Subbase .....	302.02
Tack Coat .....	406.02

*Concrete shall be in accordance with 502 except the minimum modulus of rupture shall be 550 psi at 28 days.*

COMMENTS AND ACTION

605.02 Materials  
610.02 Materials

DISCUSSION:

Mr. Reilman introduced and presented this item explaining that previous revisions to the 502 section have created strength targets that are excessive for curbing and approaches.

Mr. Reilman proposed to revise the 605 and 610 sections to revert the strength target back to 550 psi at 28 days instead of the existing 570 psi at 7 days.

Mr. Jacobs asked if this means that 605 and 610 mixes will need two beams to be lab cured to make sure that the mixture meets strength at 28 days?

Mr. Nelson responded that the intent is not to change how they're administered, it's just changing the target.

Mr. Boruff asked if we're wanting the mix to be stronger at 7 days?

Mr. Nelson said that we want them to be stronger, but not too much too quickly. We don't want the mixes to be over designed. Mr. Nelson added that we're going down the direction with mix approvals, that the CMD workbook is being changed and they have to identify what items the mixes are going to be used on at the time of submittal.

There was no further discussion and this item passed as submitted.

<p>Motion: Mr. Reilman Second: Mr. Koch and Mr. Dave Ayes: 10 Nays: 0 FHWA Approval: YES</p>	<p><b>Action:</b></p> <p><input checked="" type="checkbox"/> Passed as Submitted <input type="checkbox"/> Passed as Revised <input type="checkbox"/> Withdrawn</p>
<p>2024 Standard Specifications Sections: 605.02 pg. 508-509; 610.02 pg. 523.</p> <p>Recurring Special Provisions or Plan Details:   NONE</p> <p>Standard Drawing affected:   NONE</p> <p>Design Manual Chapter:   NONE</p> <p>GIFE Section:   NONE</p>	<p><input checked="" type="checkbox"/> 2026 Standard Specifications <input type="checkbox"/> Revise Pay Items List <input type="checkbox"/> Notification to Designers if change is <u>not</u> addressed by RSP</p> <p><input checked="" type="checkbox"/> Create RSP (No. <u>6xx-R-xxx</u>) Effective: <u>September 1, 2024</u></p> <p><input type="checkbox"/> Revise RSP (No. <u>   </u>) Effective:</p> <p><input type="checkbox"/> Standard Drawing Effective:</p> <p><input type="checkbox"/> Create RPD (No. <u>   </u>) Effective:</p> <p><input type="checkbox"/> GIFE Update <input checked="" type="checkbox"/> Frequency Manual Update <input checked="" type="checkbox"/> SiteManager Update</p>

PROPOSAL TO STANDARDS COMMITTEE

PROBLEM(S) ENCOUNTERED: A new AASHTO test method, T 384, has been created that supplements and will eventually replace NCHRP 244, Series IV, Southern Climate Weathering Test as the primary test method for Non-Epoxy PCC Sealers.

PROPOSED SOLUTION: Add AASHTO T 384 to testing requirements in 909.10.

APPLICABLE STANDARD SPECIFICATIONS: 909.10

APPLICABLE STANDARD DRAWINGS: none

APPLICABLE DESIGN MANUAL SECTION: none

APPLICABLE SECTION OF GIFE: none

APPLICABLE RECURRING SPECIAL PROVISIONS: create new 909-x-xxx RSP

PAY ITEMS AFFECTED: none

APPLICABLE SUB-COMMITTEE ENDORSEMENT: ad hoc: Irina Goloschokin, Mike Nelson, Jim Reilman

IF APPROVED AS RECURRING SPECIAL PROVISION OR PLAN DETAILS, PROPOSED BASIS FOR USE: All contracts with 707, 709, 714, or 723 pay items.

IMPACT ANALYSIS (attach report):

Submitted By: Jim Reilman

Title: State Materials Engineer

Organization: INDOT

Phone Number: (317) 522-9692

Date: 1/17/2024

IMPACT ANALYSIS REPORT CHECKLIST

*Explain the business case as to why this item should be presented to the Standards Committee for approval. Answer the following questions with Yes, No or N/A.*

Does this item appear in any other specification sections? No

Will approval of this item affect the Approved Materials List? Yes

Will this proposal improve:

Construction costs? N/A

Construction time? N/A

Customer satisfaction? N/A

Congestion/travel time? N/A

Ride quality? N/A

Will this proposal reduce operational costs or maintenance effort? N/A

Will this item improve safety:

For motorists? N/A

For construction workers? N/A

Will this proposal improve quality for:

Construction procedures/processes? Yes

Asset preservation? Yes

Design process? N/A

Will this change provide the contractor more flexibility? N/A

Will this proposal provide clarification for the Contractor and field personnel? N/A

Can this item improve/reduce the number of potential change orders? N/A

Is this proposal needed for compliance with:

Federal or State regulations? No

AASHTO or other design code? No

Is this item editorial? No

Provide any further information as to why this proposal should be placed on the Standards Committee meeting Agenda:



REVISION TO 2024 STANDARD SPECIFICATIONS

---

SECTION 909 – PAINT AND LIQUID EPOXY

909.10 Non-Epoxy PCC Sealers

The Standard Specifications are revised as follows:

SECTION 909, BEGIN LINE 383, INSERT AS FOLLOWS:

**(b) Test Report**

The testing shall be performed *in accordance with AASHTO T 384* by a recognized laboratory in accordance with ITM 806.

The non-epoxy PCC sealers shall be delivered to the jobsite in unopened containers with the manufacturer's numbered seal intact.

APPROVED MINUTES

COMMENTS AND ACTION

909.10 Non-Epoxy PCC Sealers

DISCUSSION:

This item was introduced and presented by Mr. Reilman who stated that a new AASHTO test method, T 384, has been created that supplements and will eventually replace NCHRP 244, Series IV, Southern Climate Weathering Test as the primary test method for Non-Epoxy PCC Sealers.

Mr. Reilman proposed to add AASHTO T 384 to the testing requirements in 909.10.

In the original proposal it was indicated we would make a new special provision, but I think after further thought, let's just put it in the 2026 book and we'll go from there.

There was no further discussion and this item passed as submitted.

<p>Motion: Mr. Reilman                  Second: Mr. White                  Ayes: 10                  Nays: 0                  FHWA Approval: YES</p>	<p><b>Action:</b></p> <p><input checked="" type="checkbox"/> Passed as Submitted  <input type="checkbox"/> Passed as Revised  <input type="checkbox"/> Withdrawn</p>
<p>2024 Standard Specifications Sections:                  909.10 pg. 1051.</p> <p>Recurring Special Provisions or Plan                  Details:                  NONE</p> <p>Standard Drawing affected:                  NONE</p> <p>Design Manual Chapter:                  NONE</p> <p>GIFE Section:                  NONE</p>	<p><input checked="" type="checkbox"/> 2026 Standard Specifications  <input type="checkbox"/> Revise Pay Items List  <input type="checkbox"/> Notification to Designers if change is <u>not</u>                  addressed by RSP</p> <p><input type="checkbox"/> Create RSP (No. __)                  Effective:</p> <p><input type="checkbox"/> Revise RSP (No. __)                  Effective:</p> <p><input type="checkbox"/> Standard Drawing                  Effective:</p> <p><input type="checkbox"/> Create RPD (No. __)                  Effective:</p> <p><input type="checkbox"/> GIFE Update  <input type="checkbox"/> Frequency Manual Update  <input type="checkbox"/> SiteManager Update</p>

PROPOSAL TO STANDARDS COMMITTEE

PROBLEM(S) ENCOUNTERED: The Public Right-of-way Accessibility Guidelines (PROWAG) final rule reduces the number of significant digits for the curb ramp cross slope and running slope from the nearest hundredth to the nearest tenth and uses the terms “vertical surface changes in level” instead of “vertical surface discontinuities” and “curb ramp clear area” instead of “curb ramp clear space”.

PROPOSED SOLUTION: Establish an RSP to update the tolerance for curb ramp cross slope, running slope, and curb ramp terms to match the PROWAG final rule and update the 604-SWCR Standard Drawing series for 2024 with the tolerances and curb ramp terms in the PROWAG final rule.

APPLICABLE STANDARD SPECIFICATIONS: 604

APPLICABLE STANDARD DRAWING: 604-SWCR series

APPLICABLE DESIGN MANUAL CHAPTER: IDM §51-1.0

APPLICABLE SECTION OF GIFE: §22

APPLICABLE RECURRING SPECIAL PROVISION OR PLAN DETAILS: N/A

PAY ITEMS AFFECTED: N/A

APPLICABLE SUB-COMMITTEE ENDORSEMENT: The proposed RSP has been reviewed by INDOT’s ADA Technical Advisory Committee.

IF APPROVED AS RECURRING SPECIAL PROVISION OR PLAN DETAILS, PROPOSED BASIS FOR USE:  
Required for all contracts with any **604** pay item.

IMPACT ANALYSIS (attach report): Yes

Submitted By: Joe Bruno on behalf of Dave Boruff  
Title: Sr. Traffic Engineer, Signals & Markings  
Division: Traffic Engineering  
Email: [jbruno@indot.in.gov](mailto:jbruno@indot.in.gov)  
Date: 1-25-2024

IMPACT ANALYSIS REPORT CHECKLIST

*Explain the business case as to why this item should be presented to the Standards Committee for approval. Answer the following questions with Yes, No or N/A.*

Does this item appear in any other specification sections? No

Will approval of this item affect the Qualified Products List (QPL)? No

Will this proposal improve:

Construction costs? No

Construction time? Yes

Customer satisfaction? No

Congestion/travel time? No

Ride quality? No

Will this proposal reduce operational costs or maintenance effort? No

Will this item improve safety:

For motorists? No

For pedestrians? No

For construction workers? No

Will this proposal improve quality for:

Construction procedures/processes? Yes

Asset preservation? No

Design process? Yes

Will this change provide the contractor more flexibility? Yes

Will this proposal provide clarification for the Contractor and field personnel? Yes

Can this item improve/reduce the number of potential change orders? Yes

Is this proposal needed for compliance with:

Federal or State regulations? Yes

AASHTO or other design code? Yes, PROWAG

Is this item editorial? Yes

Provide any further information as to why this proposal should be placed on the Standards Committee meeting Agenda: On 8/8/2023, the U.S. Access Board issued the final rule for the Public Right-of-way Accessibility Guidelines and this proposal will further compliance with the requirements for pedestrian facilities. The final rule is available online at:

<https://www.access-board.gov/prowag/>

REVISION TO SPECIAL PROVISIONS

604-R-XXX SIDEWALKS, CURB RAMPS, STEPS, AND HANDRAILS (proposed new)

604-R-XXX SIDEWALKS, CURB RAMPS, STEPS, AND HANDRAILS

(Adopted xx-xx-xx)

The Standard Specifications are revised as follows:

SECTION 604, BEGIN LINE 43, DELETE AND INSERT AS FOLLOWS:

**(a) General Requirements**

The location of curb ramps shall take precedence over the location of drainage structures and signal, utility, or light poles. Drainage structures and poles shall not be located within the limits of the curb ramp, exclusive of flared sides. Poles located within a sidewalk shall not reduce the clear width to less than 4.0 ft. Crosswalk markings shall be located such that the curb ramps and curb ramp clear ~~spaces~~ *areas* are contained within the markings unless otherwise specified. The flared sides need not fall within the crosswalk lines. The normal gutter flow line shall be maintained throughout the curb ramp area, and appropriate drainage structures shall be used, as needed, to intercept the flow prior to the curb ramp area. Positive drainage shall also be provided to carry water away from the intersection of the curb ramp and the gutter line.

The bottom edge of curb ramps and the top of curb shall be flush with the edge of the adjacent pavement or the gutter line. Vertical surface ~~discontinuities~~ *changes in level* shall be a maximum of 1/2 in. Vertical surface ~~discontinuities~~ *changes in level* greater than 1/4 in. up to 1/2 in. shall be beveled at a slope no steeper than 1V:2H. *Vertical surface changes in level greater than 1/2 in. shall have an 8.3% maximum slope.*

The curb ramp running slope shall not exceed 8.33%. Curb ramp and sidewalk cross slope shall not exceed 2.00%. The slope of the turning space shall not exceed 2.00% in any direction. A running slope or cross slope that exceeds the maximum shall be as shown on the plans.

Construction tolerance shall not apply to running slope and cross slope percentages.

SECTION 604, BEGIN LINE 97, DELETE AND INSERT AS FOLLOWS:

The surface shall be finished with a wooden float ~~or similar concrete finishing hand tool~~. No plastering of the surface will be allowed. The final surface shall be free from porous spots caused by the disturbance of coarse aggregate particles. Curb ramp surfaces shall be coarse broomed transverse to the running slope as shown on the plans.

SECTION 604, BEGIN LINE 263, INSERT AS FOLLOWS:

Concrete curb ramps will be measured by the square yard and will include the ramp, turning space, flared side, *return curb*, and setback. Turning spaces shared by more than one curb ramp will be measured only once. Detectable warning surfaces and retrofitted detectable warning surfaces will be measured by the square yard.

COMMENTS AND ACTION

604-R-XXX SIDEWALKS, CURB RAMPS, STEPS, AND HANDRAILS

DISCUSSION:

This item was introduced by Mr. Boruff, who chose to withdraw this item at this time. Mr. Boruff stated that this proposal will be brought back to the Committee at a future meeting along with revisions to the associated standard drawings. Ms. Mouser and Ms. Smutzer are currently working on the drawings.

<p>Motion: Mr.  Second: Mr.  Ayes:  Nays:  FHWA Approval:</p>	<p><b><u>Action:</u></b>  <input type="checkbox"/> Passed as Submitted  <input type="checkbox"/> Passed as Revised  <input checked="" type="checkbox"/> Withdrawn</p>
<p>2024 Standard Specifications Sections:  604 begin pg. 501.</p> <p>Recurring Special Provisions or Plan  Details:  (proposed new)</p> <p>Standard Drawing affected:  604-SWCR series</p> <p>Design Manual Chapter:  IDM §51-1.0</p> <p>GIFE Section:  Section 22</p>	<p><input type="checkbox"/> 2026 Standard Specifications  <input type="checkbox"/> Revise Pay Items List  <input type="checkbox"/> Notification to Designers if change is <u>not</u>  addressed by RSP</p> <p><input type="checkbox"/> Create RSP (No. __)  Effective:</p> <p><input type="checkbox"/> Revise RSP (No. __)  Effective:</p> <p><input type="checkbox"/> Standard Drawing  Effective:</p> <p><input type="checkbox"/> Create RPD (No. __)  Effective:</p> <p><input type="checkbox"/> GIFE Update  <input type="checkbox"/> Frequency Manual Update  <input type="checkbox"/> SiteManager Update</p>